

NEW



The new Comfort

Impressively comfortable and durable.

www.boeckmann.com



FIRST CLASS TRANSPORT



High class.

Just like the Comfort. Because the name of this full polyester horse trailer means what it says. More space in the head area for your horse, larger entrance doors and a unique space with the new tack locker concept make a difference in practice. In addition, the sporty, dynamic design and the "CFFplus" comfort suspension chassis make a brilliant impression on every tour; driving pleasure guaranteed. The reinforced full polyester body and the quality aluminium floor included as a standard feature are particularly robust and durable. The Multi Safe System (MSS) is also part of the Böckmann safety guarantee. Explore all the standard equipment and added value of the new Comfort on the following pages. We hope you enjoy browsing through the brochure.

Klaus Böckmann

Contents

The family company	4
Comfort	6
Standard features	8
Room concept and tack locker	12
Added value	16
Colours and decors	26
Accessories	28
Service	30
The Böckmann World	32



From the idea to the product: Anton Böckmann laid the foundations of the company with skilful craftsmanship and passion for his work.



Unforgettable: The four young Böckmann brothers on "Raudi", their first Shetland pony.



Important hands-on experience: Klaus Böckmann handling his own horses.



Effective training means greater success: Gilbert Böckmann at the stables of Böckmann Pferde GmbH.



The next generation has now also joined the company's management team: Stella Böckmann and Justus Böckmann.



One big family: from a small blacksmith's workshop to the Böckmann Group – with a workforce of more than 500 in 2022.



The headquarters of Böckmann Fahrzeugwerke GmbH are located in Lastrup, Lower Saxony.

Böckmann. The family company.

The company's development from a small village smithy to an international market leader has been shaped above all by one sentence: "You have to put your heart and soul into the business to be successful in the long term." This conviction, which Brigitte and Anton Böckmann have passed on to the family since the company was founded in 1956, still holds true today. With Stella Böckmann and Justus Böckmann the third generation of the company also stands for transport solutions which are characterised by first-class quality, the best design and absolute reliability.

Another decisive part of the successful Böckmann DNA is also a matter close to the heart of the family members – their passion for equestrian sport. Looking after your own horses every day is both an inspiration and an opportunity to test vehicle developments. Only developments that have proven their worth are taken into production. This is how the company has been manufacturing horse trailers that deliver real added value for more than 65 years.



The founders: Anton († 2010) and Brigitte Böckmann († 2011).

Comfort.

New design, additional length, height and width in the interior, more space in front of the horses, higher entrance door, higher side walls and a new tack locker concept with additional storage space – the new Comfort model combines unique added values that make the difference in practice in this full polyester class.



Plenty of space for your horse, a larger entrance door and a new tack locker concept ensure a unique range of space.



Standard highlights.

The exclusive features such as the outstanding travelling comfort due to the "CFFplus" comfort suspension chassis, the large tack locker with extensive equipment and the extra high side walls ensure comfort and safety as standard.

For further details on the standard features of the individual models visit: www.boeckmann.com



Plenty of space and comfort
due to the easily accessible tack locker with clever details and extensive standard accessories (for more information about the tack locker turn to page 15).



Safe transport
is ensured by the track-proven Böckmann partition wall system and the safety stall bar system (MSS) with tie rings and an adjustable height range of 10cm. Further protection is provided by the additional stall bar padding as well as the padding and kick protection on the side walls (the latter is an accessory).



Fast safety in emergencies
with the track-proven Multi Safe safety stall bar panic system (MSS) for front and rear. The wheel spanner is included in the standard equipment.

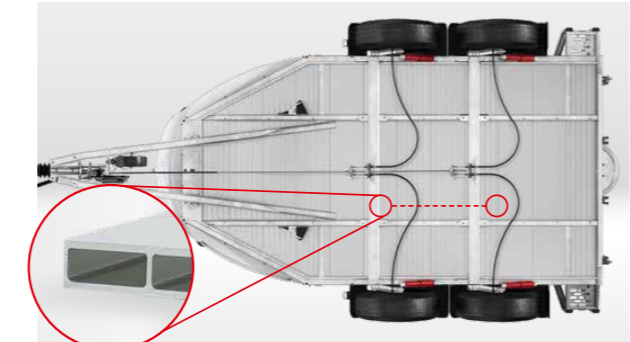
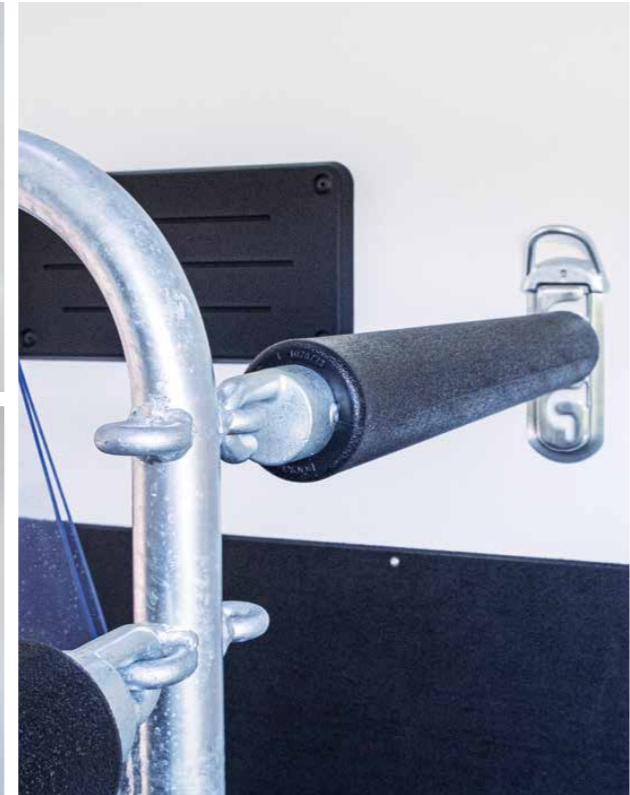

Robust and rot-proof
due to the solid quality full aluminium floor with closed profile for reinforcement in the horse compartment.



More space when loading and unloading
due to the wide entrance, the light and inviting interior and the cleverly designed partition wall system.



PVC canvas lift
with integrated net and roll-up function.

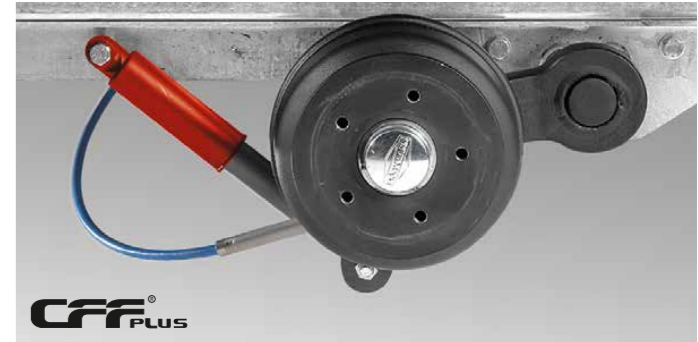

Optimum road handling
with the lowered comfort suspension chassis with wheel shock absorbers and soft suspension.

Even more standard equipment.

The standard features of the Comfort model already stand out with many details and innovations from which horse and rider benefit every day.



Safe hitching and unhitching

with the lockable cast coupling with rubberised, convenient heart-shaped handle and soft top (crash protection).

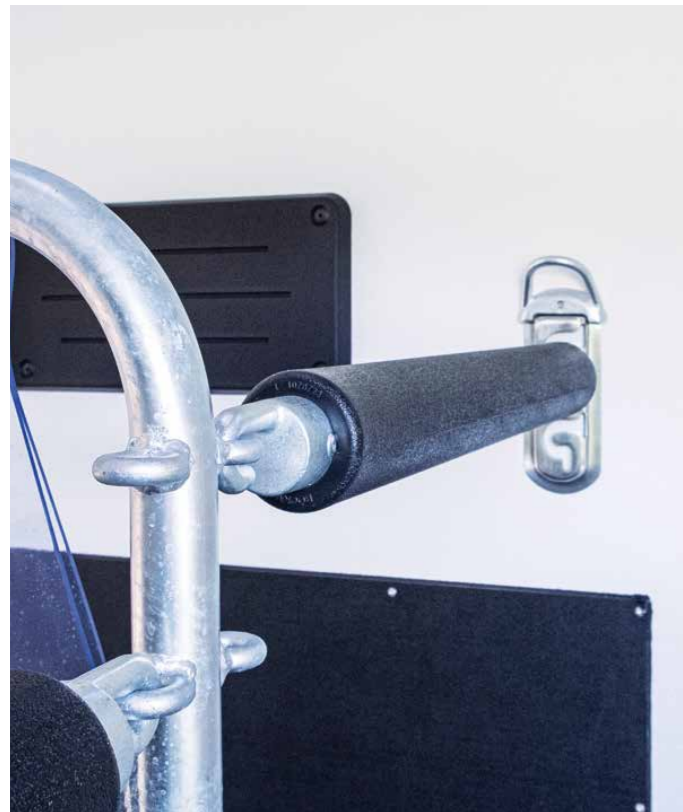

Comfortable standing position

due to the additional stall bar padding as well as the padding and kick protection on the side walls (the latter is an accessory).



Good ventilation, light interior and sun protection

due to the pop-up side windows. Dazzle-free, with sunshade and safety grille.



Calming atmosphere

provided by the blue LED transport light – can be conveniently switched from blue to white.



Simple operation

due to the automatic jockey wheel – extra-long with an easy-to-handle crank and perfect to use, even in cold weather.



Body made of reinforced full polyester

for outstanding durability.

Additional standard features

- Strong construction due to the V2A stainless steel bolted connections
- Longitudinal beam chassis with V-drawbar (bolted)
- Lighting system with reversing light and 13-pin connector
- Generously dimensioned quality tyres
- Lifting device on the rear ramp
- Closed rear struts
- 4 rear ramp hinges
- Manoeuvring handle
- Horsehead decor on rear ramp
- Lockable doors with 3-point door locking system and rain gutter
- Böckmann partition wall: transparent PVC divider, flexible with PVC top section
- Rubber floor (8 mm) with anti-slip textile structure, bonded and sealed
- Rubber covering on rear ramp with step bars, water drain gutter and side stops

All standard features and more are described at www.boeckmann.com

Plenty of room.

In addition to the pleasure of driving with the Comfort, its name says it all: Comfort for horses and riders. The additional length, height and width in the interior and the intelligent layout provide more space in front of the horses, more headroom and additional storage space in the tack locker. Take a look at the many highlights of the standard equipment.

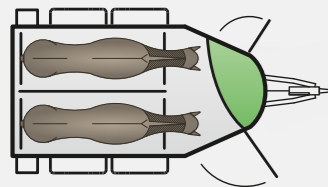

Comfort

Large horse compartment with Böckmann partition wall, space in front of the horses, a man-high access door and a tack locker accessible from the outside.



Space, safety and comfort for horses and riders

with unique, generous dimensions, plenty of space in front of the horses, man-high access door and convenient access to the tack locker.

Even more space.

Maximum benefits, safe handling of the horse and features that you can rely on. Discover more about the Comfort and find out which features suit you.



Maximum comfort for horses and riders
due to a unique space design and man-high access door.

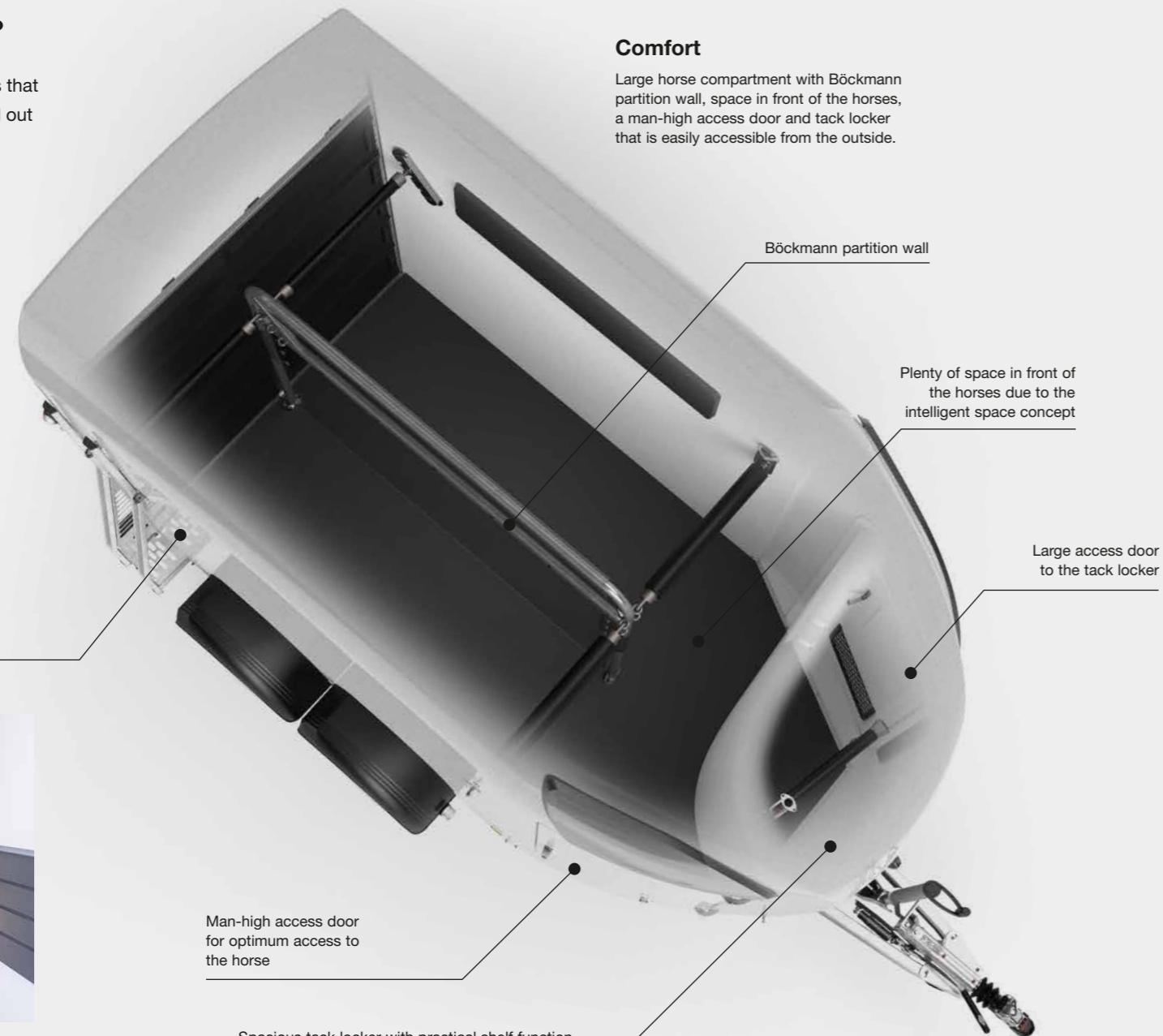

Comfort

Large horse compartment with Böckmann partition wall, space in front of the horses, a man-high access door and tack locker that is easily accessible from the outside.

Böckmann partition wall

Plenty of space in front of the horses due to the intelligent space concept

Large access door to the tack locker

Man-high access door for optimum access to the horse

Spacious tack locker with practical shelf function, easily accessible from the outside

The tack locker.

The new tack locker concept offers optimal room for a maximum storage of the equipment. The now even larger door allows convenient access to the tack locker and ensures convenient use of the storage space. Discover the extensive range of standard features.

Practical shelf with optimised cleaning
with defined water drainage. The special shape with large radii does not have any edges for the horse to bite.



Everything is conveniently accessible from outside with the large tack locker door with rain gutter. Perfect closure with the 3-point door lock and rubber seal.



Tack locker

accessible from outside with practical storage options such as 1 shelf. In addition to the horizontally and vertically adjustable as well as pull-out saddle racks, a telescopic broom, plastic shovel, door net, mirror, riding crop holder, large bridle hooks, pad holder, LED light and folding stool with safety catch are also included in the standard equipment.

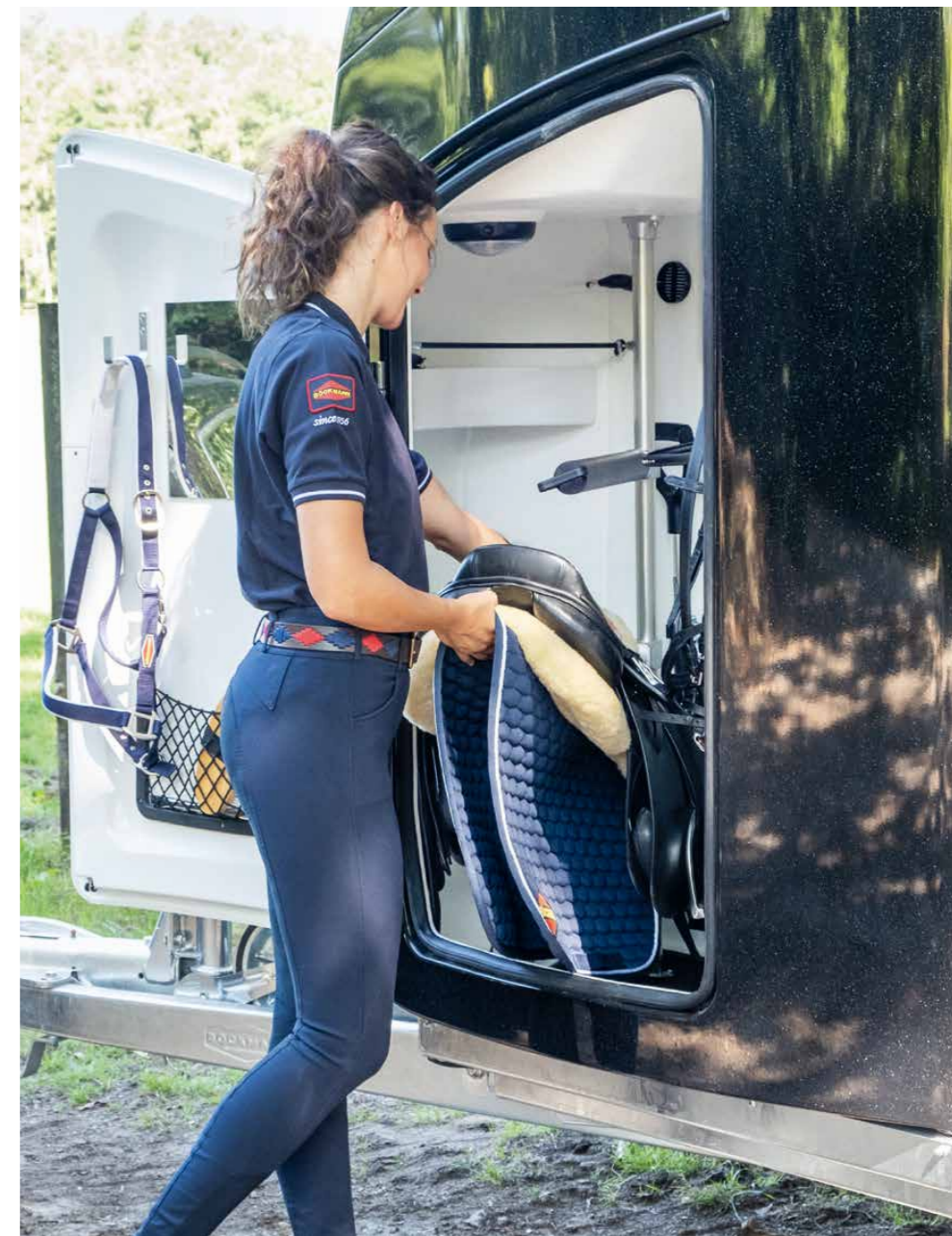

Good for your horse.

The loading height, the light interior with plenty of headroom, the Multi Safe System (MSS) and the absolute absence of sharp corners and edges – the safety of your horses is our main priority. These detailed solutions – standard features on all Böckmann horse trailers – have been developed on the basis of 65 years of experience gained with our own horses and have been consistently adapted to their well-being and comfort.

For further details on the **Böckmann safety concept** and the added advantages visit www.boeckmann.com



Large and inviting entrance

due to the narrow roof edges, interior canvas lift and the bright, white interior walls. At night the interior lighting provides sufficient light in the interior.



Low loading height

due to the lowered "CFFplus" comfort suspension chassis with wheel shock absorbers and soft suspension.

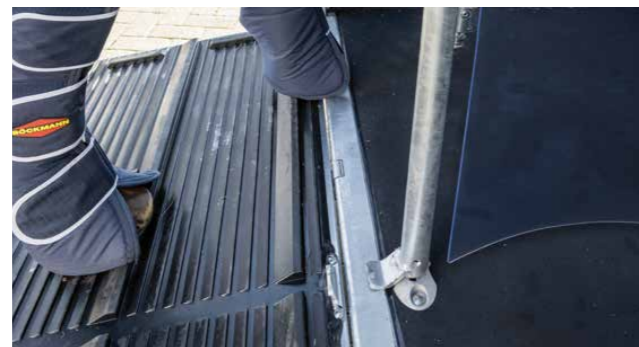

Optimum foothold and minimised risk of slipping

due to safety treads, side stops on the rear ramp covering and the narrow rear ramp hinge.



Lots of room for a wide stance

due to securing of the PVC curtain 600mm above the floor – for comfortable transport.



Safe transport

ensured by the track-proven Böckmann partition wall system and the safety stall bar system (MSS) with tie rings and an adjustable height range of 10 cm. Further protection is provided by the additional stall bar padding as well as the padding and kick protection on the side walls (the latter is an accessory).





No slipping of the horse's hooves and good visibility from the car
due to closed, perforated rear struts; the large lighting unit is visible even when the rear ramp is open.



Safe to stand on
due to the rubber floor with non-slip textile structure (picture shows rubber wear mat as accessory).



No sharp edges and corners
ensured by rounded hinges and plastic covers on the steel profile struts and at the ends of the rear struts.



Safety
with the robust, angle lever locks with 180° rotation that minimise the risk of injury to your horse.



PVC canvas lift
with integrated net and roll-up function.



Good ventilation, light interior and sun protection
due to the pop-up side windows. Dazzle-free, with sunshade and safety grille.



Plenty of headroom, space and light interior
due to the generous space concept of the Comfort model. The tinted pop-up windows with integrated grille, large radii without corners and edges and flat hinges provide additional protection.



Calming atmosphere
provided by the blue LED transport light – can be conveniently switched from blue to white.



Fast safety in the event of an emergency
with the track-proven Multi Safe safety stall bar panic system (MSS). Can be released at the front and rear. The wheel spanner is included in the standard equipment.

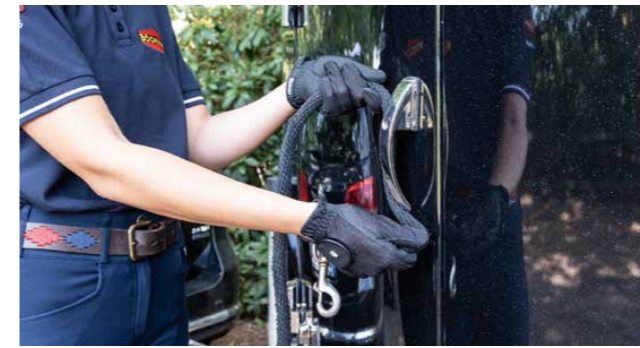

No entangling of the rope
due to flat door handles.



Plenty of room for the tail
due to the generous clearance between the stall bar and the rear ramp.



Easily accessible hay
with optimally positioned hooks and counterholder for a hay net. The specially shaped tack locker with its large radii does not have any biting edges for the horse.

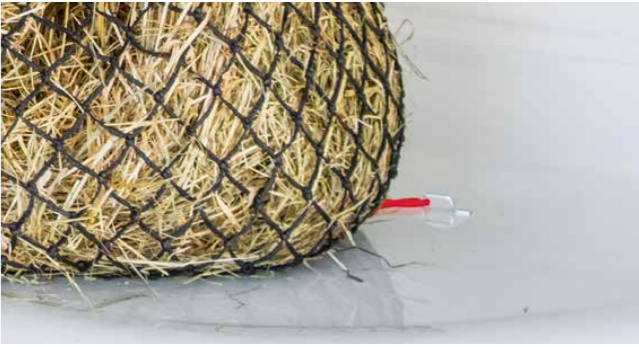

Good for you.

In addition to the needs of the horses, our horse trailers are tailored to the requirements of the riders. Innovations such as the chassis, the coupling and the automatic jockey wheel prove their worth in daily use. Details such as the crop holder, the mounting step and the extra wide bridle hooks at the right place show that during development the main focus was on one main thing – practical experience for practical applications.

For further details on the extra advantages visit www.boeckmann.com



Optimum closure
with the 3-point door lock and rubber seal.



Safe hitching and unhitching
due to the lockable cast coupling with rubberised, convenient heart-shaped handle and soft top (crash protection).

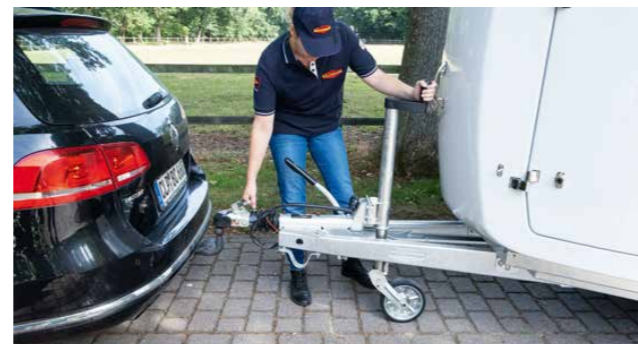

Easy manoeuvring
due to the automatic jockey wheel – extra-long with an easy-to-handle crank and optimally positioned manoeuvring handle, perfect to use, even in cold weather.



Crash and theft protection
provided by the lockable cast-iron coupling with soft-top crash protection and rubberised, convenient heart-shaped handle.



Unimpeded access to the car boot
due to the rubberised, convenient heart-shaped coupling handle and the flat brake lever – also when attached.



Convenient operation
due to the easily accessible and separate light switch for the interior lighting on the right-hand entrance door.



Plenty of space for loading and unloading
due to the large clearance between the stall bar and tack locker in the front area of the trailer.



Quick access to the horse compartment
through a man-high entrance door and plenty of space once inside.



Excellent view on the road
due to closed, perforated rear struts.



One key for all locks
with a master key in triplicate for the tack locker door, access door and cast coupling.

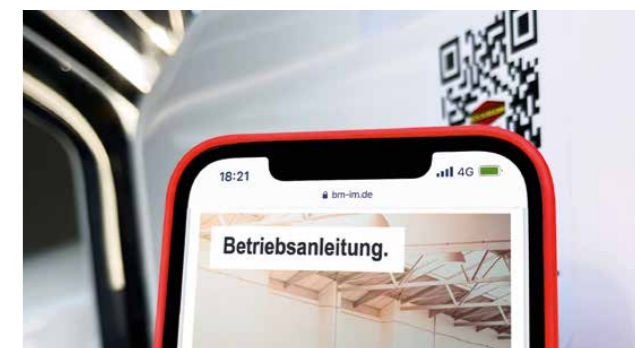

Fast access to the operating instructions
with the QR code directly on the vehicle.



Tack locker as a shelf

with an optimised design and plenty of space and no biting edge for the horses. Practical cleaning with defined water drainage.



Mudguards as shelf

with the wide and open, straight form of the impact-resistant plastic or polyester mudguards (accessory).

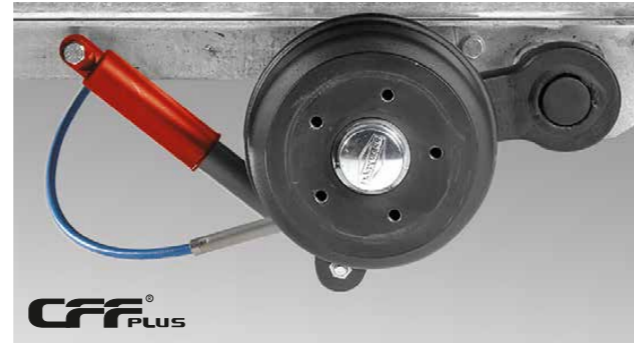

Optimum road handling

with the lowered comfort suspension chassis with wheel shock absorbers and soft suspension.



Practical protection against damage

with door catches on the doors.



Protection from rain

provided by the rain gutters above the doors and also in the rear area.



More travelling safety

due to the large-dimensioned quality tires. Alu rims available as accessory.



Simple operation

due to the practical roll-up function of the PVC canvas lift. Lifting device for easy opening of the rear ramp, additionally with new, robust double step.



Easy to tow

due to the aerodynamic body and low centre of gravity – also saves fuel.



Convenient operation and extensive standard features in the tack locker

with a door catch as well as a telescopic broom, plastic shovel, door net, mirror, crop holder, large bridle hooks, pad holder, LED light and folding stool with safety catch.



Tie options

with lots of fittings on and in the trailer.

Good for lasting value.

Original Böckmann quality down to the last detail – for you this means durability and a high resale value. This is achieved by absolutely solid workmanship and the use of high-quality materials. Experience the strength and safety of our horse trailers yourself.

For further details on the extra advantages visit www.boeckmann.com

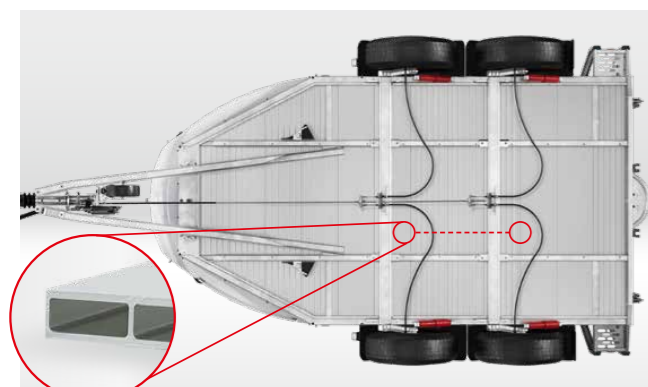

Robust, rot-proof and made for high loads

due to the solid quality full aluminium floor with closed profile for reinforcement in the horse compartment as well as the longitudinal beam construction and the welded, hot-dip galvanised steel frame.



Strong frame

due to a full-length Z-profile frame of galvanised special steel – firmly bolted to the body.

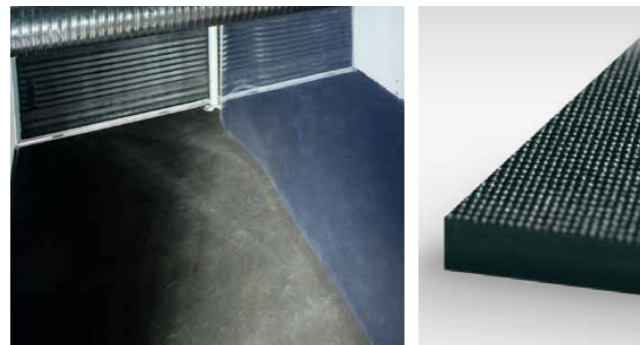

Resilient

due to the fully bonded and sealed rubber floor (8 mm) throughout.

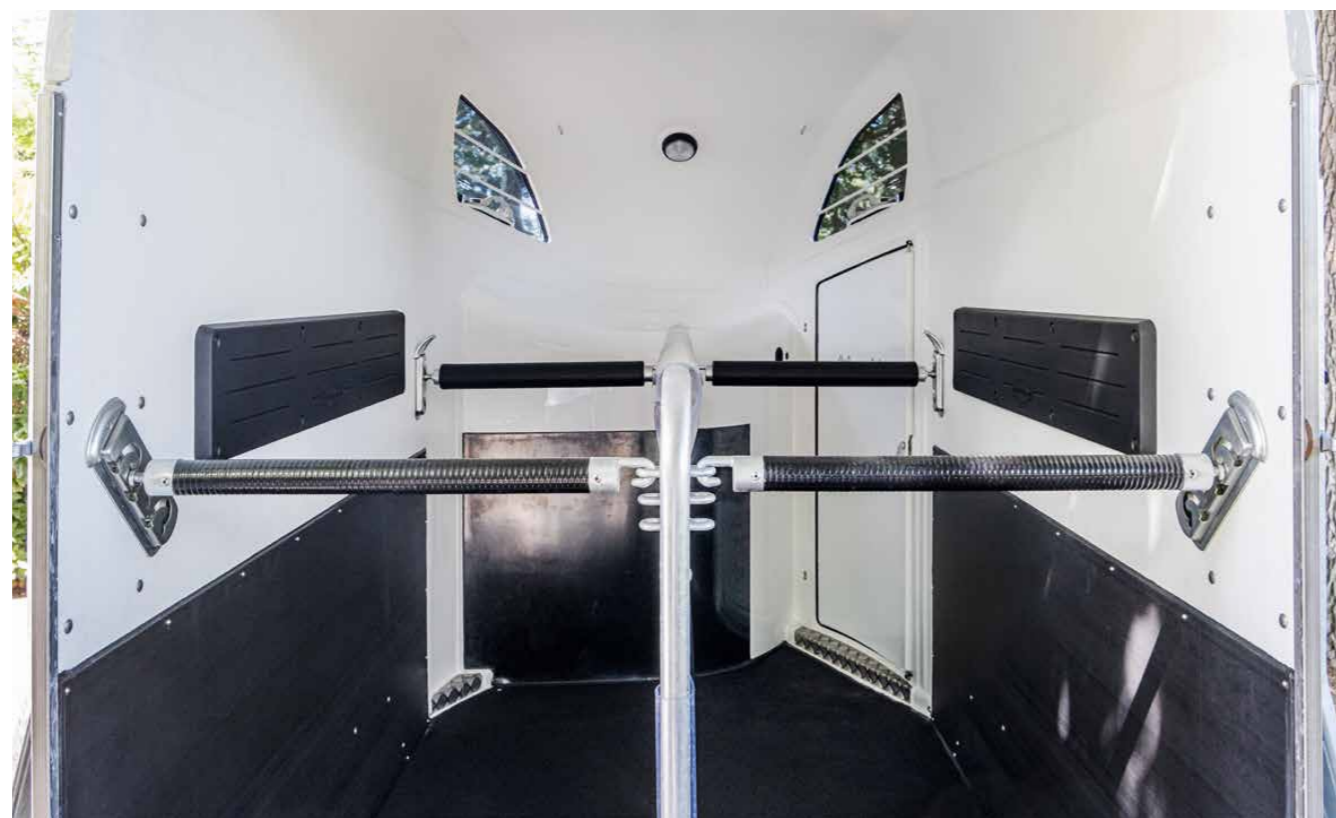

Kick protection

with a particularly impact-resistant plastic on the side walls and in front of the horse (both accessories).



Robust rear ramp

with four galvanised steel profile struts with integrated lifting device; additionally with new, robust double step.



Strong partition wall construction and high-quality materials

due to the solid, welded steel frame.



Body made of reinforced full polyester

for outstanding durability.



Higher payload

due to the 2400 kg total weight as a standard feature instead of 2000 kg.

Great design.

Individuality in its most appealing form: All Comfort models can be designed according to your taste. Lots of colour combinations are possible – from the roof to the body to the covers for side braces. We would also be pleased to offer you individual and photorealistic lettering according to your specifications. Simply ask the Böckmann specialist dealer in your area.



The Comfort with polyester parts in anthracite² or flame red³.



White²



Silver metallic¹



Anthracite metallic²



Slate grey³



Silver grey³



Dark blue metallic²



Red metallic²



Green metallic²



Dark brown metallic²



Royal blue³



Flame red³



Magenta³



Yellow³



Yellow green³



Deep orange³

¹ Standard ² Without surcharge ³ With surcharge

Experience has shown that printing inks cannot reproduce the original colour of paintwork. We therefore recommend that you ask your Böckmann partner to show you the colour samples. Individual colour combinations, special finishes as well as letterings based on your design are possible. Your Böckmann specialist dealer will be pleased to help you.

Great outlook.

Create “your Böckmann” according to your personal preferences. Large or small decor, multi-colour or monochrome – the choice is yours. The decors are exclusively designed by Jan Künster for Böckmann. We would be pleased to create custom decors and custom sizes based on your design upon request. Your Böckmann partner would be pleased to help you.



Small decor
Positioning example of small decor motif “Competition, multi-colour”.



Large decor
Positioning example of large decor motif “Competition, greyscale”.



Strong trot, multi-colour

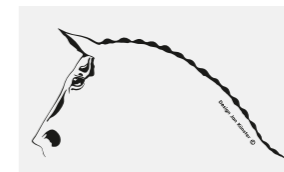

Horse's head

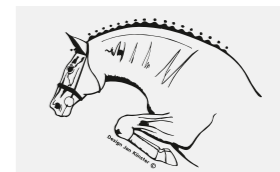

Jumper

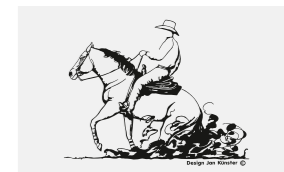

Western

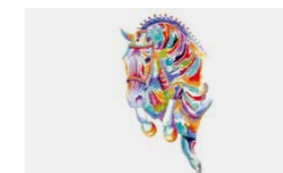

Jumper, multi-colour



Gaited horse

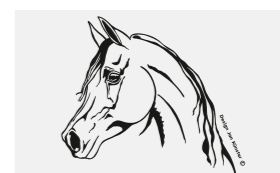

Arabian



Driving sport

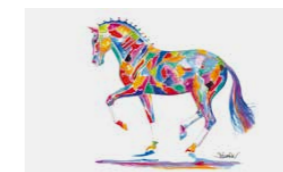

Piaffe, multi-colour

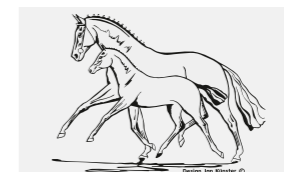

Mare with foal



Dressage



Frisian

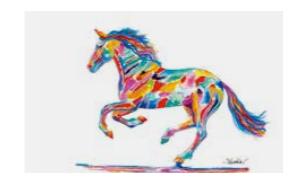

Gallop, multi-colour

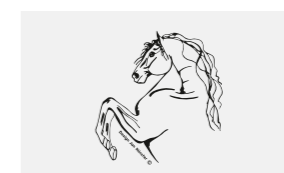

Andalusian

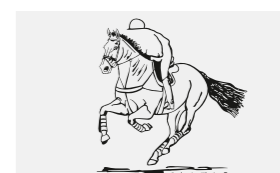

Military



Artline



Competition, multi-colour



Competition

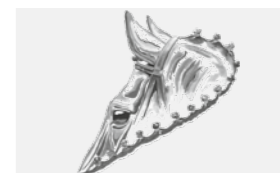

Competition, greyscale

All decors are also available in anthracite or silver as a standard feature. Additional decor colours available on request.

Accessories.

The range of standard features of the Comfort model is extensive. It has an impressive range of details and innovations from which both horses and riders benefit. Even more is possible with the original Böckmann accessories: Customise your Comfort to suit your needs and those of your horses.



Discover the full range of accessories and configure your Comfort online:
www.boeckmann.com/en/configurator



Many possible applications
with the rear ramp/door combination.



Safety on the road
with a folding foal grid.



Easy mounting
with the climbing aid that can be easily unfolded on the rear ramp; this also puts less strain on the horse's back.

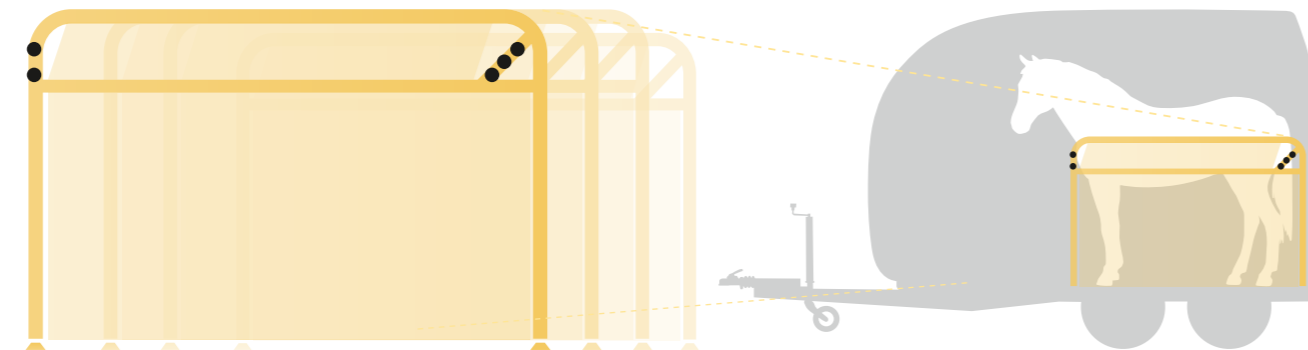

Comfortable transport for horses of all sizes
with the partition wall concept. You can equip your horse trailer with a partition wall that perfectly suits your horse upon request. The 165 partition wall is the standard size for large horses (1.65m height), the partition wall can also be selected from the accessory range for horses with a height of 1.45m, 1.55m or 1.80m without any extra charge.



Practical storage option
with a tie up bar and saddle pad (on the side of trailer).



Safe transport
due to the aluminium head divider wall e.g. for transporting two stallions.



Optimum ventilation
with a roof vent in the polyester roof.



Several safety features
such as the anti-torsion coupling [1] (up to 2.7 t total weight, not lockable), the weatherproof protective cover [2] and the spare wheel with spare wheel holder and a spare wheel cover [3].



More light at the rear
with the additional interior light.



Visual highlight
with the polyester cover for side braces, the single polyester fenders, as well as the Böckmann Premium aluminium rims.



Everything in view
with the video surveillance of the horse compartment as well as an additional rear view camera.



Durability
with the kick protection in front of the horses [1] and the wear mat in the area of the front legs [2].

First class service.

As a Böckmann customer you will receive personal support with many service offers directly on site. Our dense network of competent and trained Böckmann sales partners is at your disposal worldwide. They will be able to provide you with the excellent trailer advice and top-notch service you need. We have put together more information and tips for you in our online service portal:



Original part orders

Guaranteed exact fit, reliability, durability in daily use and a higher resale value. Original Böckmann parts can be purchased from your local dealer.

www.boeckmann.com/en/accessories



Repair service

Trained employees take care of all repairs and the installation of original parts if necessary. Also together with the next general inspection upon request.

www.boeckmann.com/en/services



Böckmann magazine

Read our Böckmann magazine for important information, trade fair dates and helpful trailer tips. Take a look inside:

www.boeckmann.com/en/magazineazine/magazin



Böckmann FAQs

Frequently asked questions about transport, trucks and trailers. We support you with answers so that you are perfectly prepared for your transport task.

www.boeckmann.com/en/services/faqs



Böckmann partners

Find your personal Böckmann dealer at home and abroad with ease. Refer to our dealer locator at:

www.boeckmann.com/en/dealer-locator

Böckmann financing options.

Would you like to finance or lease a new Comfort? Simply contact your local dealer and ask about the various options. Your Böckmann dealer will be happy to help you.

Ask your local dealer!



Trailers shown may include special accessories.

Get moving with Böckmann. First class and hand in hand.

The Böckmann brand has stood for progress, quality and reliability since 1956. Our services and products are designed to inspire people time and time again and deliver real added value. "You have to put your heart and soul into the business to be successful in the long term" was the guiding principle of our founders. And this is still a living part of the company today and every day. Welcome to the world of Böckmann.



Böckmann trailers

A success story which started in 1956: As the trailers are used for Böckmann's own horses, they have been subjected to constant improvement over the years. In this way we became the international market leader for horse trailers.



Böckmann horses

Everything for your horses. Everything from one source. Everything in Hamstrup! Ranging from horse-friendly accommodation with individual care to foaling and successful training in dressage and show jumping by the renowned trainer Gilbert Böckmann and his team.



Böckmann transporters

Thanks to the experience of over 65 years of equestrian sport, we develop horse trucks that leave nothing to be desired. Whether in the living or sleeping compartment or the horse compartment – every single detail is designed and produced individually in Lastrup. And naturally hand-crafted. Let us advise you directly at the Truck Center.



Böckmann Collection

From sweat rugs to polo shirts to folding rules – discover the entire Böckmann Collection. Simply scan the QR code and explore the entire range.



Find out more about Böckmann:











facebook.com/anhaengersterklasse

boeckmann.com/youtube

instagram.com/boeckmann.horses



Technical data

									
 Comfort	2400 kg*	2745 mm	2220 mm	4500 mm	2315 mm	1650 mm	3353 mm	1422 kg	

Changes to design and equipment reserved. Weights and dimensions approximate and may change due to additional equipment. * 2400 kg for standard version; weight reduction to 2000 kg possible

Your Böckmann specialist dealer for consulting and service:

Böckmann Fahrzeugwerke GmbH 49688 Lastrup
 Phone +49 (0) 4472 895-0 Fax +49 (0) 4472 895-550
 info@boeckmann.com www.boeckmann.com
 f facebook.com/anhangersterklasse ▶ boeckmann.com/youtube
 @ instagram.com/boeckmann.horses



FIRST CLASS TRANSPORT