

NEW



The new Portax family

Reliably robust and practical down to the last detail.

www.boeckmann.com



FIRST CLASS TRANSPORT

First class & practical.

For more than 65 years we have been designing horse trailers that are precisely tailored to the needs of horses and their riders, that meet the highest quality standards and offer a host of advantages in everyday equestrian life. These are characteristics that we have developed even further in the latest generation of these horse trailers – naturally with the experience gained with our own horses. We hope you enjoy browsing through this brochure and finding out more about our new range.

Klaus Böckmann

Contents

The family company	4
The Portax family	6
Portax SKA and Portax L SKA	8
Portax E and Portax L E	10
Portax K and Portax L K	12
Portax L SR	14
Big Portax and Big Portax Stall	16
Standard features	18
Room concepts	22
Tack lockers and rooms	30
Light concept	38
Added value	40
Colours and decors	50
Accessories	52
Service	56
The Böckmann World	58



1st place in the category „horse trailers“
Böckmann has been named the favourite brand in the horse trailer category more than five times in a row.



From the idea to the product: Anton Böckmann laid the foundations of the company with skilful craftsmanship and passion for his work.



Unforgettable: The four young Böckmann brothers on "Raudi", their first Shetland pony.



Important hands-on experience: Klaus Böckmann handling his own horses.



Effective training means greater success: trainer Gilbert Böckmann.



The next generation has now also joined the company's team: Stella Böckmann and Justus Böckmann.



One big family – from a small blacksmith's workshop to the Böckmann Group – with a workforce of more than 500 in 2023.



The headquarters of Böckmann Fahrzeugwerke GmbH are located in Lastrup, Lower Saxony.

Böckmann. The family company.

The company's development from a small village smithy to an international market leader has been shaped above all by one sentence: "You have to put your heart and soul into the business to be successful in the long term." This conviction, which Brigitte and Anton Böckmann have passed on to the family since the company was founded in 1956, still holds true today. With Stella Böckmann and Justus Böckmann the third generation of the company also stands for transport solutions which are characterised by first-class quality, the best design and absolute reliability. Another decisive part of the successful Böckmann DNA is also a matter close to the heart of the family members – their passion for equestrian sport. Looking after your own horses every day is both an inspiration and an opportunity to test vehicle developments. Only developments that have proven their worth are taken into production. This is how the company has been manufacturing horse trailers that deliver real added value for more than 65 years.



The founders: Anton († 2010) and Brigitte Böckmann († 2011).

The new Portax family.

The Portax horse trailers made of anodised aluminium are reliably sturdy and practical down to the last detail. The individual space concepts of the various models, the generous dimensions and the extensive range of standard features make the Portax horse trailer the perfect companion for everyday life at the stables.

With the additional space, the new generation of the Portax family is even more precisely tailored to the needs of horse and rider; more space in front of the horses, pioneering tack locker concepts with additional storage space and a design that perfectly combines form and function with the innovative lighting bow.

Take a look at the many extra benefits, the Böckmann safety guarantee and the equipment highlights and find out which Portax model is the right one for you.



The Portax family, from left to right: Portax L E, Portax L SKA, Portax L K, Portax L SR, Big Portax Stall, Big Portax, Portax K, Portax SKA, Portax E.

Experience the new Böckmann Portax models in the video: Scan the code now!



Portax SKA, Portax L SKA.

The new Portax SKA and L SKA offer a ground-breaking space concept with a tack locker that is accessible from both the inside and outside. With the extra space in front of the horses, the man-high entrance door and the new tack locker design with larger doors and additional storage space, the advantageous benefits of these models are unparalleled.

Find out which Portax model is right for you on page 22; the SKA or the L SKA with 630 mm additional interior length.

You can take a look at the impressive standard equipment highlights such as the World-Class "WCFplus" chassis, the MSS safety stall bar system and the rear ramp/door combination from page 18 onwards.



SKA

L SKA

Optimised for use from the inside and access from the outside

with the new tack locker with a larger door, more storage space and additional storage options. The man-high entrance door and the extra space in front of the stall bar ensure perfect functionality.



Portax SKA

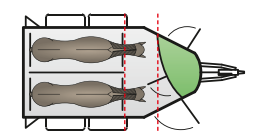

Portax L SKA

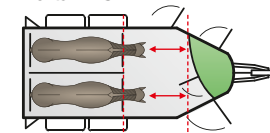

+ 630 mm

Portax E, Portax L E.

The new Portax E and L E are true space marvels and uniquely comfortable. The new tack locker with additional storage space and two larger doors are perfectly designed to be accessed from the trailer or through the two man-high entrance doors from the outside. The additional space in front of the horses guarantees even better handling and plenty of freedom of movement.

Turn to page 22 to find out which Portax model is right for you; the E or the L E with 630 mm extra inside length.

You can take a look at the impressive standard equipment highlights such as the World-Class "WCFplus" chassis, the MSS safety stall bar system and the rear ramp/door combination from page 18 onwards.



Two man-high entrance doors and two large tack locker doors ensure unique functionality. The extra space in front of the stall bar makes using the inside tack locker a real pleasure.

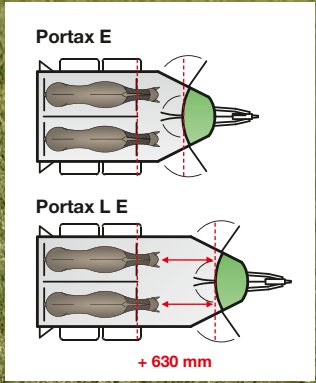

Portax K, Portax L K.

The new Portax K and L K redefine the added value of a horse trailer with front exit. The unique room layout with the extra space in front of the horses enables perfect handling. The interior tack locker is ideally configured to this purpose and with the even larger door can now be conveniently accessed from the trailer or through the man-high entrance door.

Turn to page 22 to find out which Portax model is right for you; the K or the L K with 630 mm extra inside length.

You can take a look at the impressive standard equipment highlights such as the World-Class "WCFplus" chassis, the MSS safety stall bar system and the rear ramp/door combination from page 18 onwards.



Functional and excellently designed for unloading with additional space in front of the horses, a large interior tack locker and a man-high entrance door.

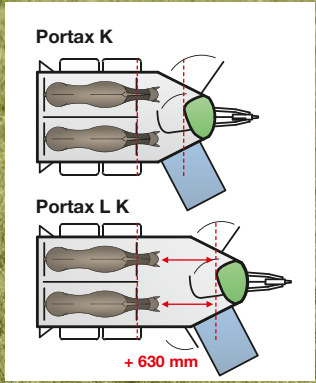

Portax L SR.

The new Portax L SR features an even larger walk-in tack room with man-high door: From the bridle hooks to the storage space to the saddle rack, everything is simply ideal. The horses can be conveniently reached from the outside through the two man-high entrance doors.

You can take a look at the impressive standard equipment highlights such as the World-Class "WCFplus" chassis, the MSS safety stall bar system and the rear ramp/door combination from page 18 onwards.



Large walk-in tack room and convenient access through the total of three man-high entrance doors (the door in the partition is available as an optional accessory).

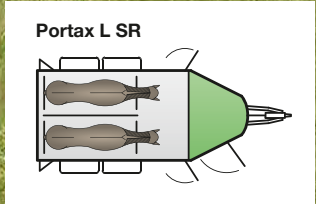

Big Portax, Big Portax Stall.

The Big Portax and Big Portax Stall are just that – Big. With an interior height and width of 2400 x 1855 mm, these horse trailers offer even more space and comfort for you and your horses. From the walk-in tack room to the horse compartment – the unique design also leaves nothing to be desired. The man-high entrance doors on each side make the trailer really easy to use.

The Big Portax Stall also features a unique partition wall system with various options for dividing the space. Contact-free transport for driving stallions with the integrated head partition wall and partition door between the horses' heads or a communal space for mares and foals – it's your decision.



Big Portax



Big Portax Stall

Even more space, walk-in tack rooms, man-high entrance doors and two space concepts with a centre post partition wall and fixed intermediate wall in front of the horses in the Big Portax (optional passage door available) or a higher stall partition wall with two hinged doors in the Big Portax Stall.

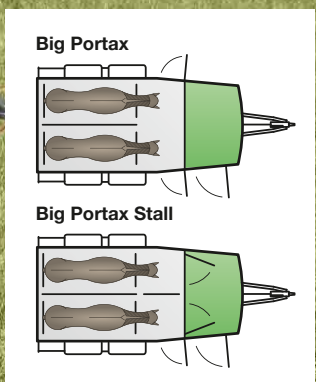

Standard highlights.

The exclusive features such as the outstanding travelling comfort due to the World-Class "WCFplus" chassis to automotive standard, the rear ramp/door combination as well as the large tack lockers and rooms with extensive equipment ensure comfort and safety as standard.



Plenty of space and comfort
due to the tack lockers and rooms with clever details and extensive standard accessories (for more information about the tack lockers turn to page 30).



Safe transport
is ensured by the track-proven Böckmann partition wall system and the safety stall bar system (MSS) with tie rings and an adjustable height range of 10cm. Further protection is provided by the additional stall bar padding as well as the padding and kick protection on the side walls.

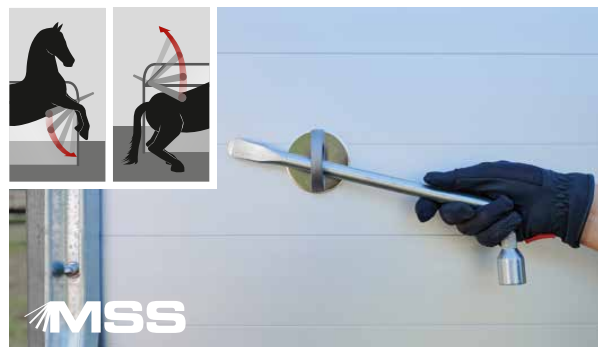

Fast safety in emergencies
with the track-proven Multi Safe safety stall bar panic system (MSS) for front and rear. The wheel spanner is included in the standard equipment.

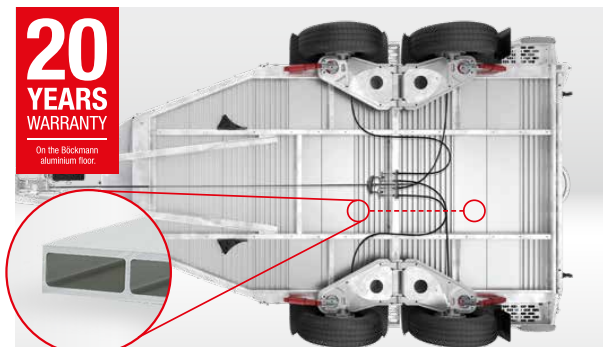

Robust and rot-proof
due to the solid quality full aluminium floor with closed profile for reinforcement in the horse compartment.



More space when loading and unloading
due to the wide entrance, the light and inviting interior and the cleverly designed partition wall systems.



NEW
Eccentric clamp
for easy removal of the centre post partition wall, for example when transporting a mare and her foal.



NEW
Simple fixing
of the partition wall sections on both sides using practical magnetic stops for even more convenience during loading.



Travelling comfort
with the World-Class chassis to automotive standards with wheel shock absorbers.

Even more standard equipment.

The standard features of the Portax family already stand out with many details and innovations from which horse and rider benefit every day.



Robust rear ramp

with four galvanised steel profile struts with integrated lifting device for easy opening of the rear ramp, additionally with new double step.



Comfortable standing position

due to the additional stall bar padding as well as the padding and kick protection on the side walls.



Good ventilation, light interior and sun protection

with several horizontally opening side windows with safety grilles and sunshades [1] as well as the new Portax lighting bow (not on Big Portax models) [2] at the front. Also refer to page 38.



Safe hitching and unhitching

with the lockable cast coupling with rubberised, convenient heart-shaped handle and soft top (crash protection).



Calming atmosphere

provided by the blue LED transport light – can be conveniently switched from blue to white.



Easily accessible feed

with two safety feeding troughs in an optimum position for the horses. Conveniently stowable in the tack locker.



Many possible applications

with the rear ramp/door combination.



Robust structure made of anodised aluminium double web profile

for safety and durability.



Simple operation

due to the automatic jockey wheel, extra-long with handy plastic crank, perfect to operate even in cold weather (heavy duty jockey wheel on the Big Portax models).



Canvas lift

with automatic roll-up function (Big Portax) [1] and integrated net (Portax and Portax L) [2].

For further details on the standard features of the individual models visit:

www.boeckmann.com



Plenty of room. Portax and Portax L.

The Portax family is reliably robust and practical in every detail, with generous dimensions for plenty of headroom and comfort. The horse trailers are tailored exactly to the needs of horse and rider, guarantee practical operation and have numerous safety features.

The different Portax and Portax L models with 630 mm extra interior length offer unique space options and various added values in practical use. Take a look at the many highlights yourself and find out which Portax horse trailer is the right one for you.

The differences between the Portax and Portax L using the SKA as an example:

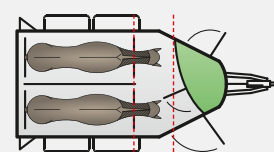

Portax SKA

Large horse compartment with plenty of headroom, space in front of the horses and a man-high entrance door. The tack locker is accessible from inside and outside.

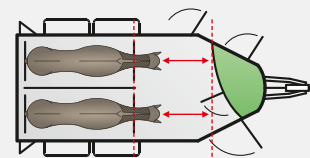

+ 630 mm

Portax L SKA

Plenty of headroom and extra interior length in the horse compartment, which means even more space in front of the horses and another man-high entrance door to the horses. The tack locker is accessible from inside and outside.

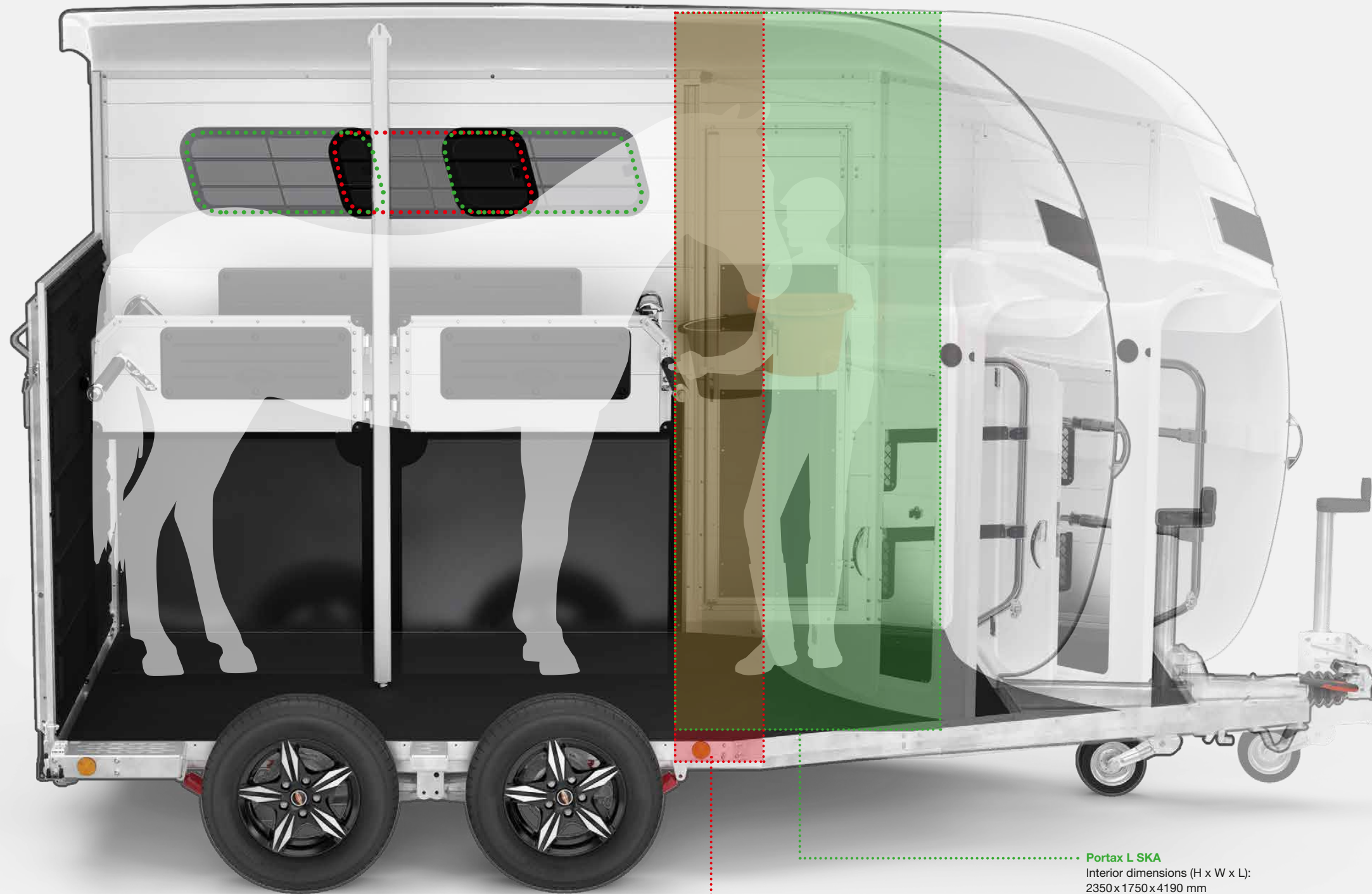

Portax SKA
Interior dimensions (H x W x L):
2350 x 1750 x 3560 mm

Portax L SKA
Interior dimensions (H x W x L):
2350 x 1750 x 4190 mm



SKA



SKA



L SKA



L SKA

Even more space. Big Portax and Big Portax Stall.

The Big Portax models stand for size, safety and extra-large, walk-in tack rooms. The amount of space is unique and offers an even higher degree of comfort and more freedom of movement for horse and rider. As the largest vehicles in their class, there are no limits to what you can do with the Big Portax and Big Portax Stall.

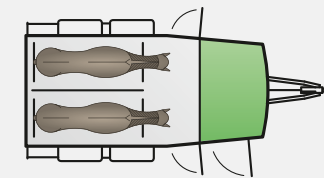

Big Portax

Large horse compartment with Böckmann centre post partition wall, plenty of head-room, space in front of the horses and two man-high entrance doors. The walk-in tack room is separated by a partition wall and is accessible through a man-high door.

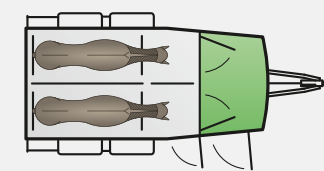

Big Portax Stall

Large horse compartment with stall partition wall with integrated head partition wall and partition door between the horses' heads as well as a man-high entrance door. The tack room is accessible from the inside through hinged doors or from the outside through a man-high entrance door.

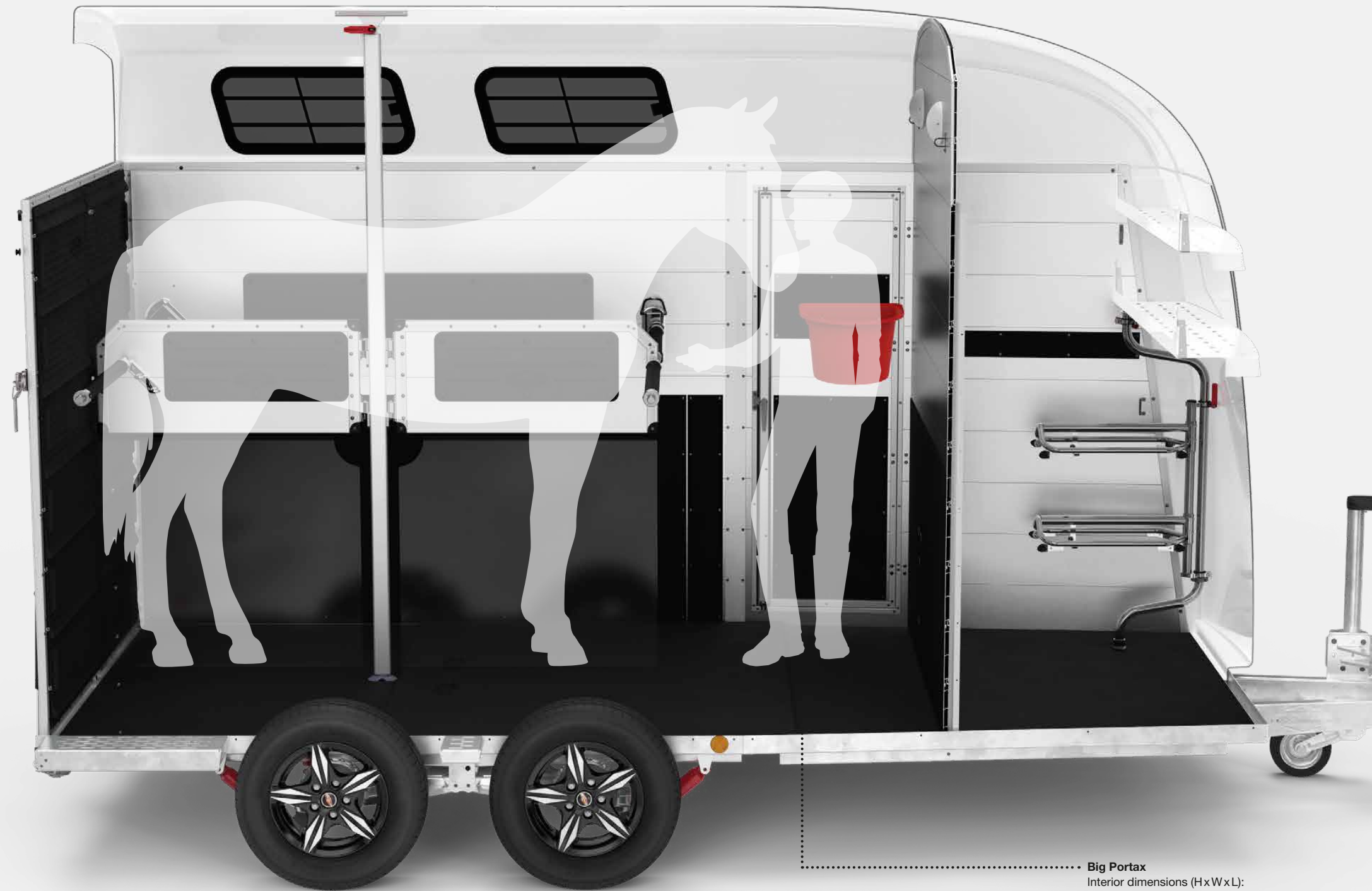

Big Portax
Interior dimensions (HxWxL):
2400x1855x4150 mm

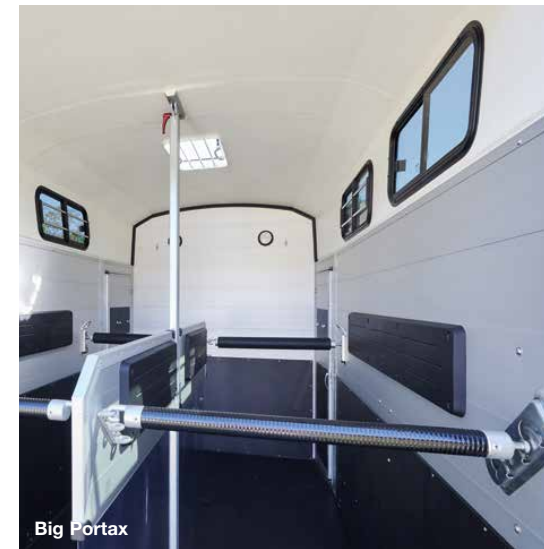

Big Portax



Big Portax

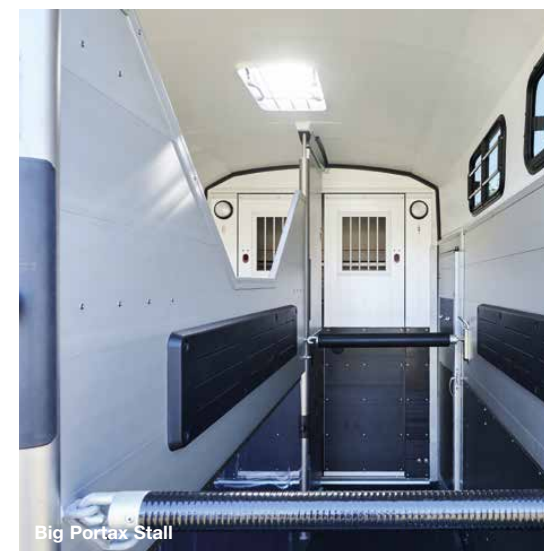

Big Portax Stall



Big Portax Stall

The overview.

Generous dimensions, extra high side walls, plenty of headroom, lots of space in front of the horses and unique practical advantages.

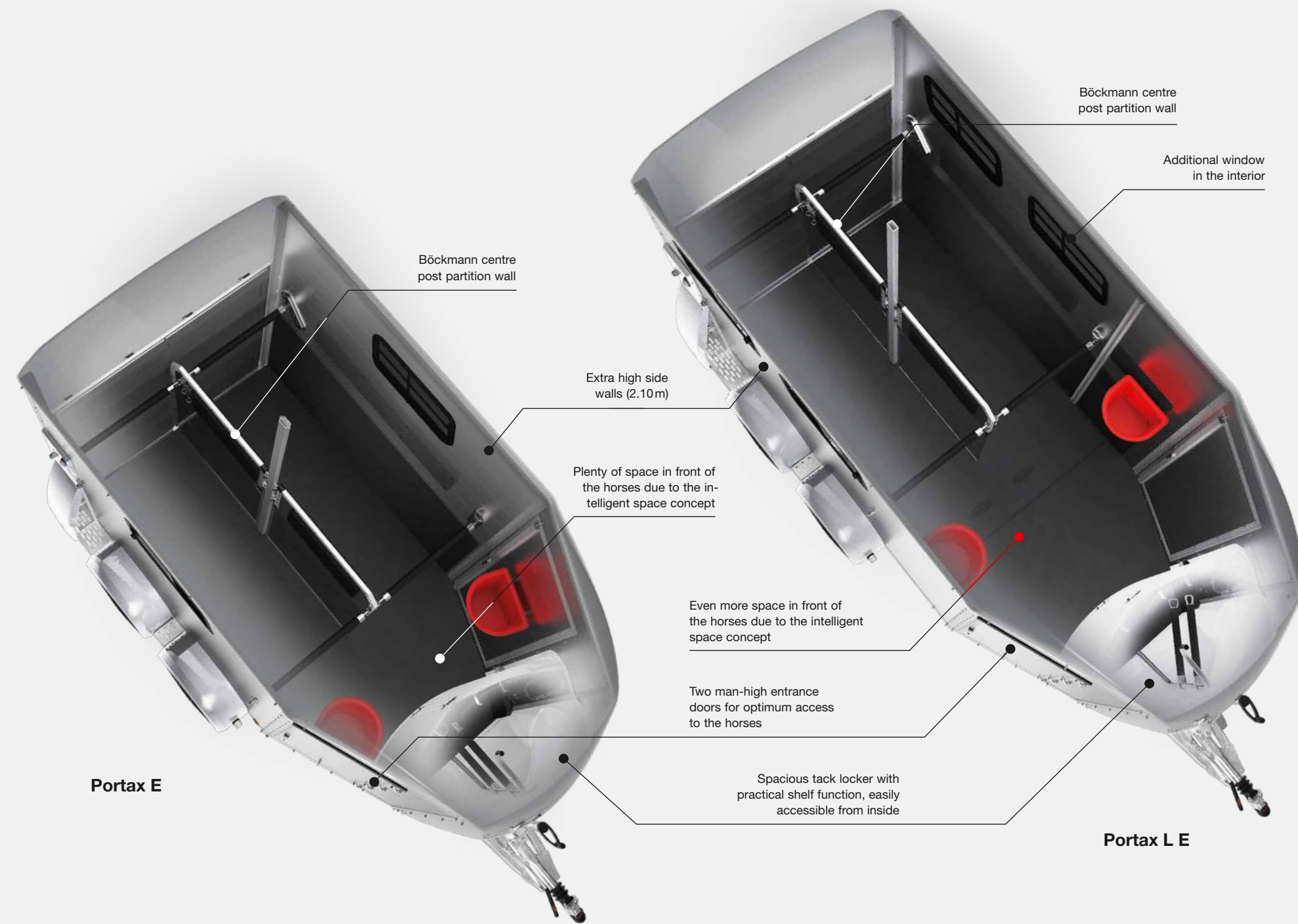
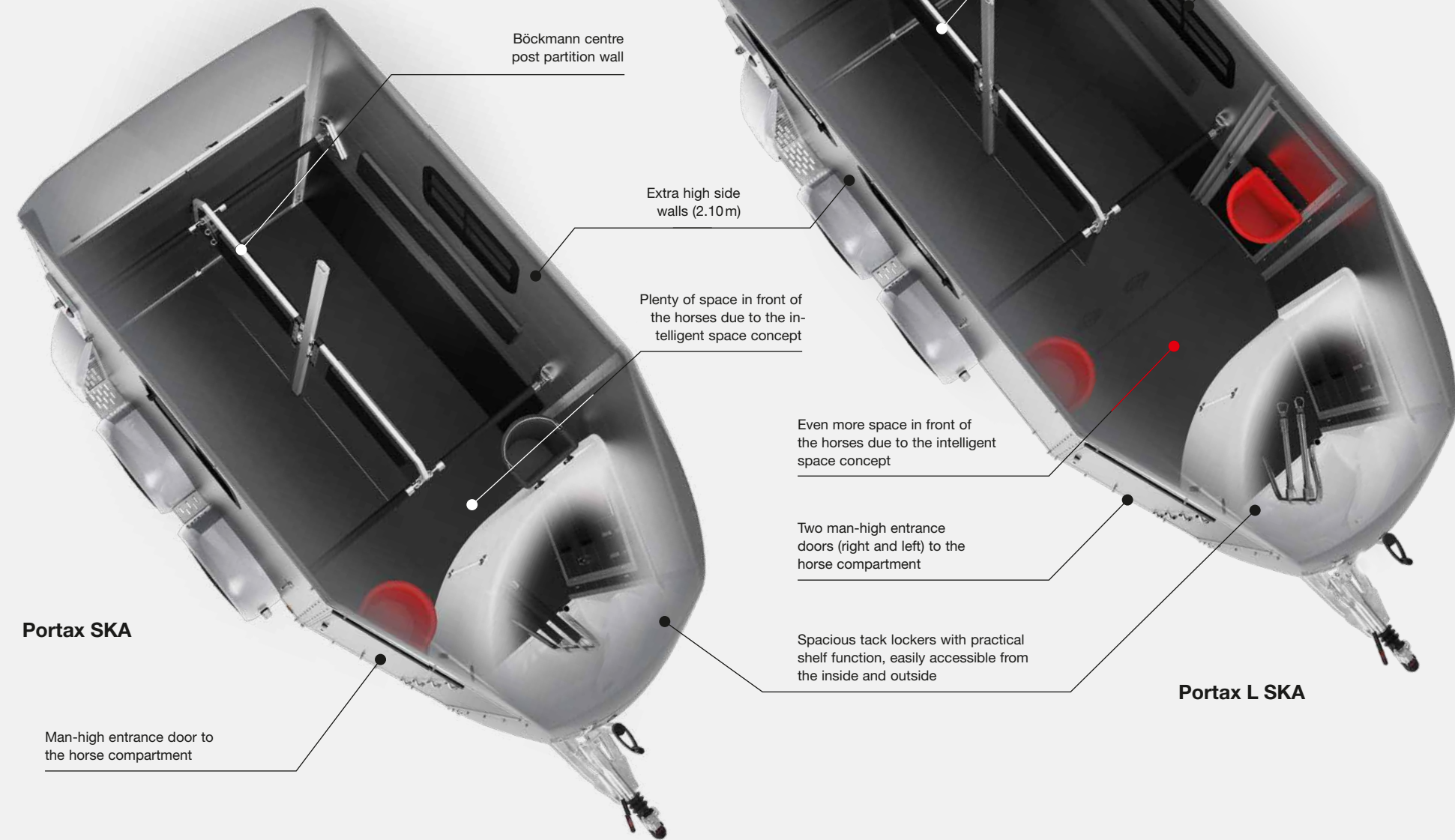

The overview.

Generous dimensions, extra high side walls, plenty of headroom, lots of space in front of the horses and unique practical advantages.

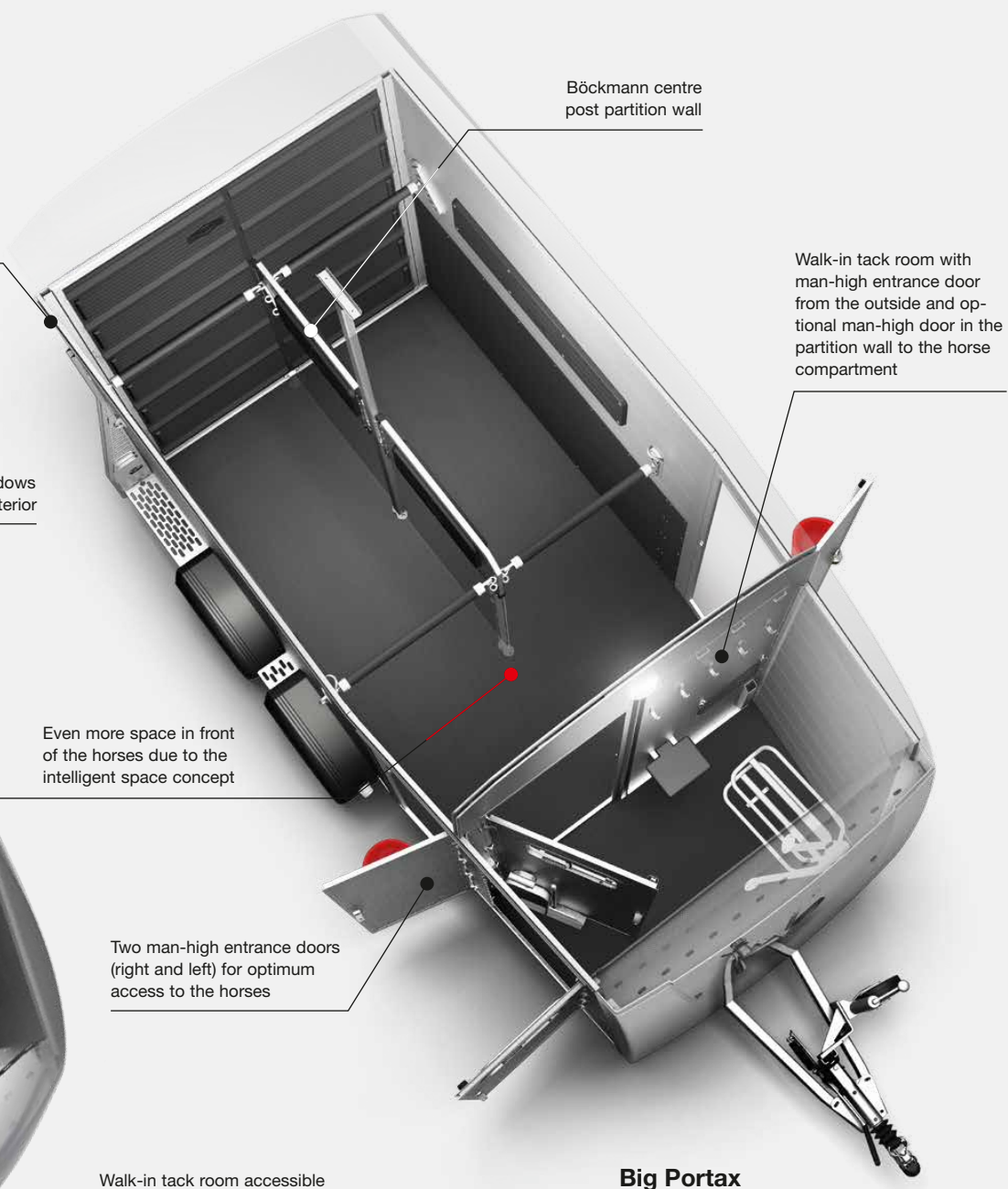
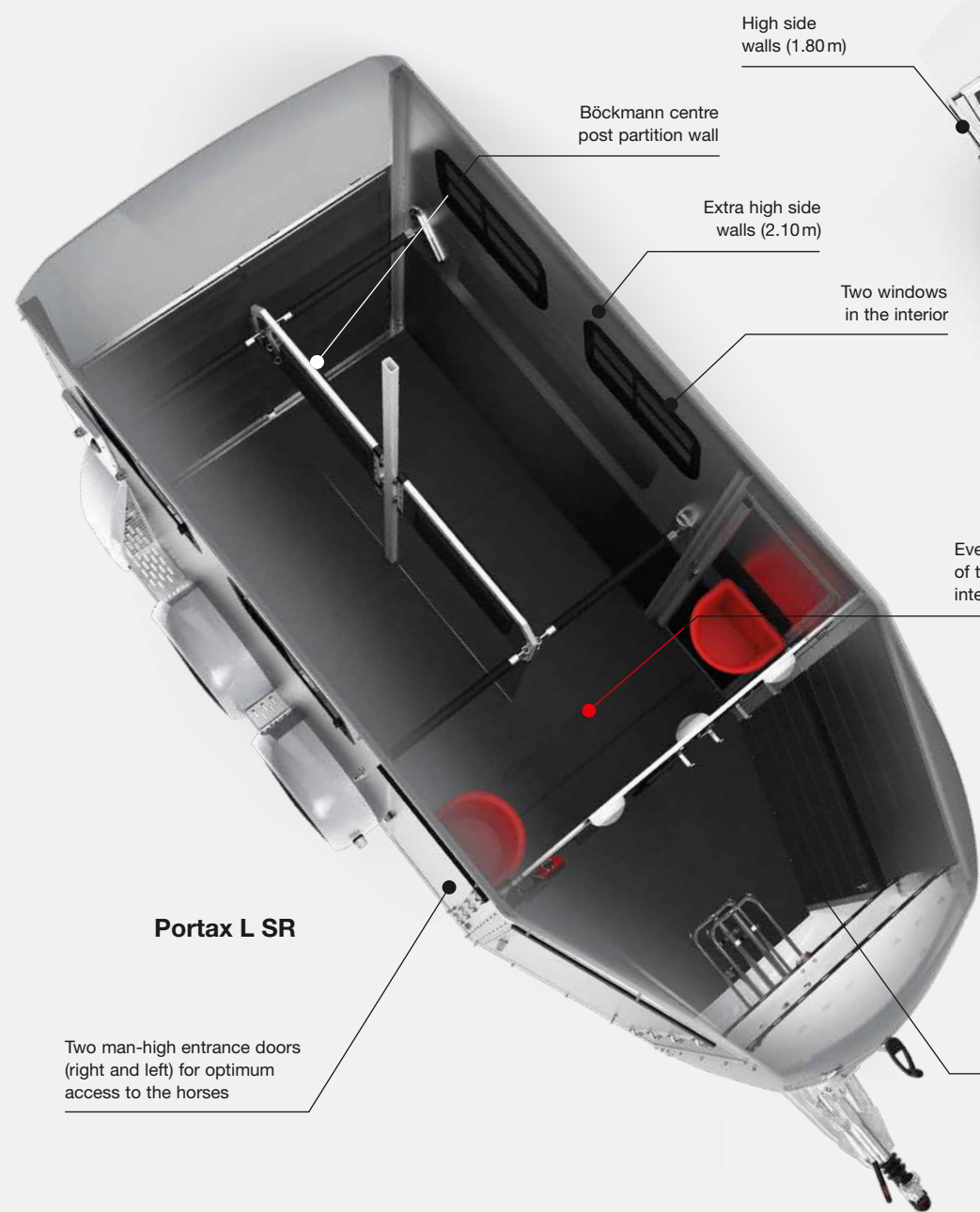
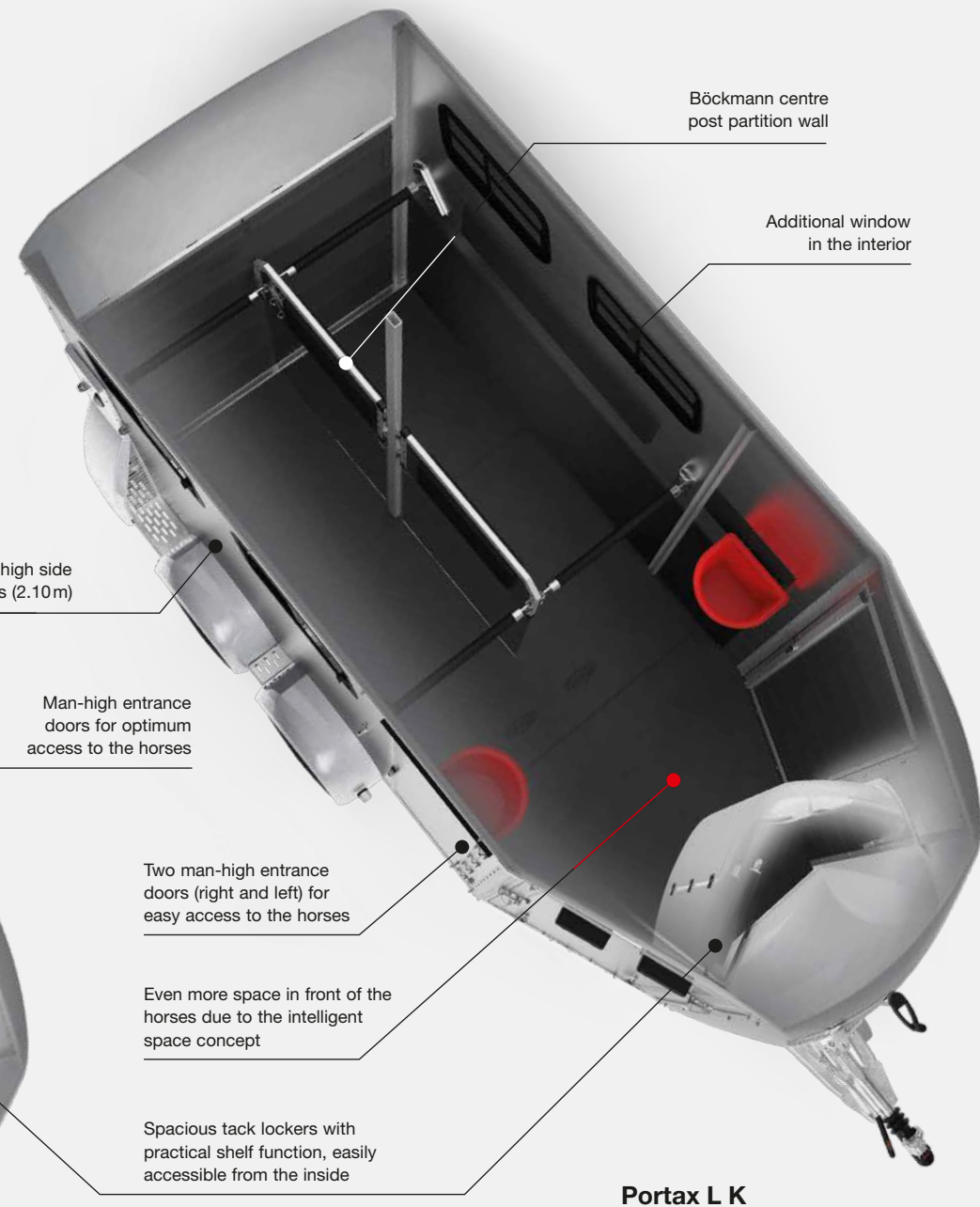
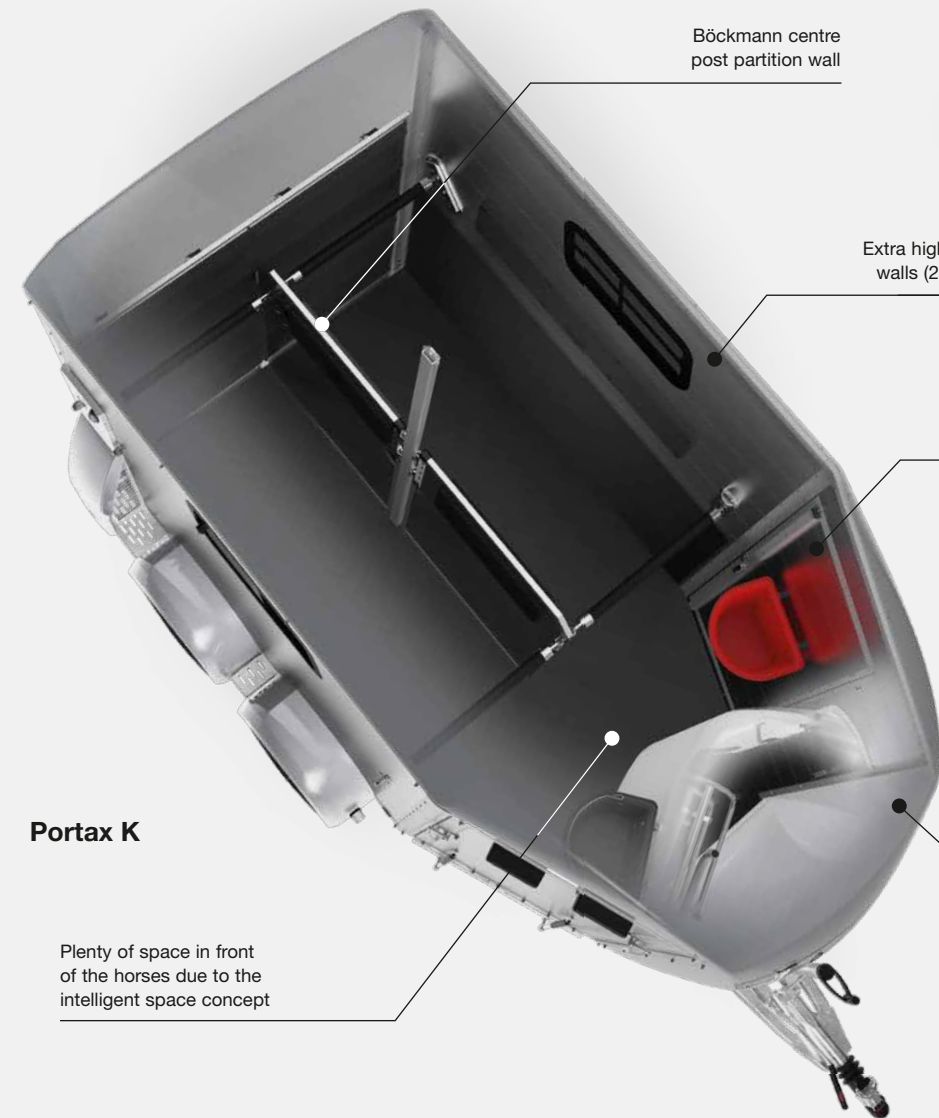

Big Portax Stall
 Scan the code now to get the overview of the Big Portax Stall.



Tack lockers and rooms. Basic features.

Bridle hooks exactly where you need them. Saddle racks that are easy to use and storage space such as shelves, nets and riding crop holder that are simply practical. In addition, all models have extensive standard equipment. Take a look at the overview of our highlights.

Practical shelf with optimised cleaning

with defined water drainage. The special shape with large radii does not have any edges for the horse to bite.



Portax L SKA

Optimum closure
with the 3-point door lock and rubber seal.



Portax L SR



Portax L E

Practical storage options
with large shelves.



Big Portax

Wide range of standard features
In addition to the horizontally and vertically adjustable as well as pull-out saddle rack or professional saddle rack, a telescopic broom, plastic shovel, door net, mirror, riding crop holder, feed troughs, large bridle hooks, pad holder, LED light and folding stool with safety catch are also included in the standard features (the quantity depends on the model). Folding seat and boot jack are standard on Portax L SR and Big Portax models.



Portax L E

Optimum configuration
for maximum storage space e.g. with pull-out saddle rack, shelves and door net.



Portax L E

LED lighting
conveniently switched on and off.



No sharp edges and corners
due to rounded hinges.

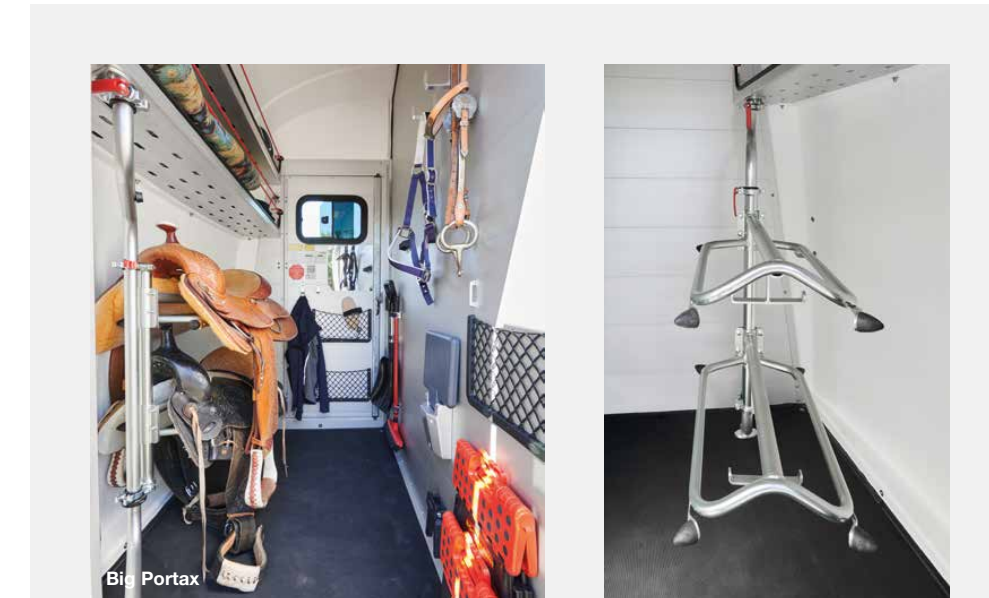

Big Portax

The western equipment
is characterised by the professional saddle racks with a wide support surface, which makes them ideal for the safe transport of the larger western saddles. These are available as accessories for the Portax SKA, L SKA and Big Portax. On the Portax K, L K and Portax L SR, they are already part of the standard equipment. The optimised space concepts also guarantee sufficient space for western equipment.



Protection from rain
by the rain guttering above the tack locker door.

The tack locker concepts are shown on the following pages.

The tack lockers. Portax SKA and Portax L SKA.

The tack lockers of the new SKA models are conveniently accessible from inside and outside. The door to the horse compartment as well as the even larger exterior tack locker door ensure maximum convenience. Access to the horses is possible through the man-high exterior door.

We have summarised the extensive range of standard features and unique detailed solutions such as pull-out saddle racks, storage compartments, bridle hooks and folding stools for you on page 30.



Portax L SKA



Portax SKA

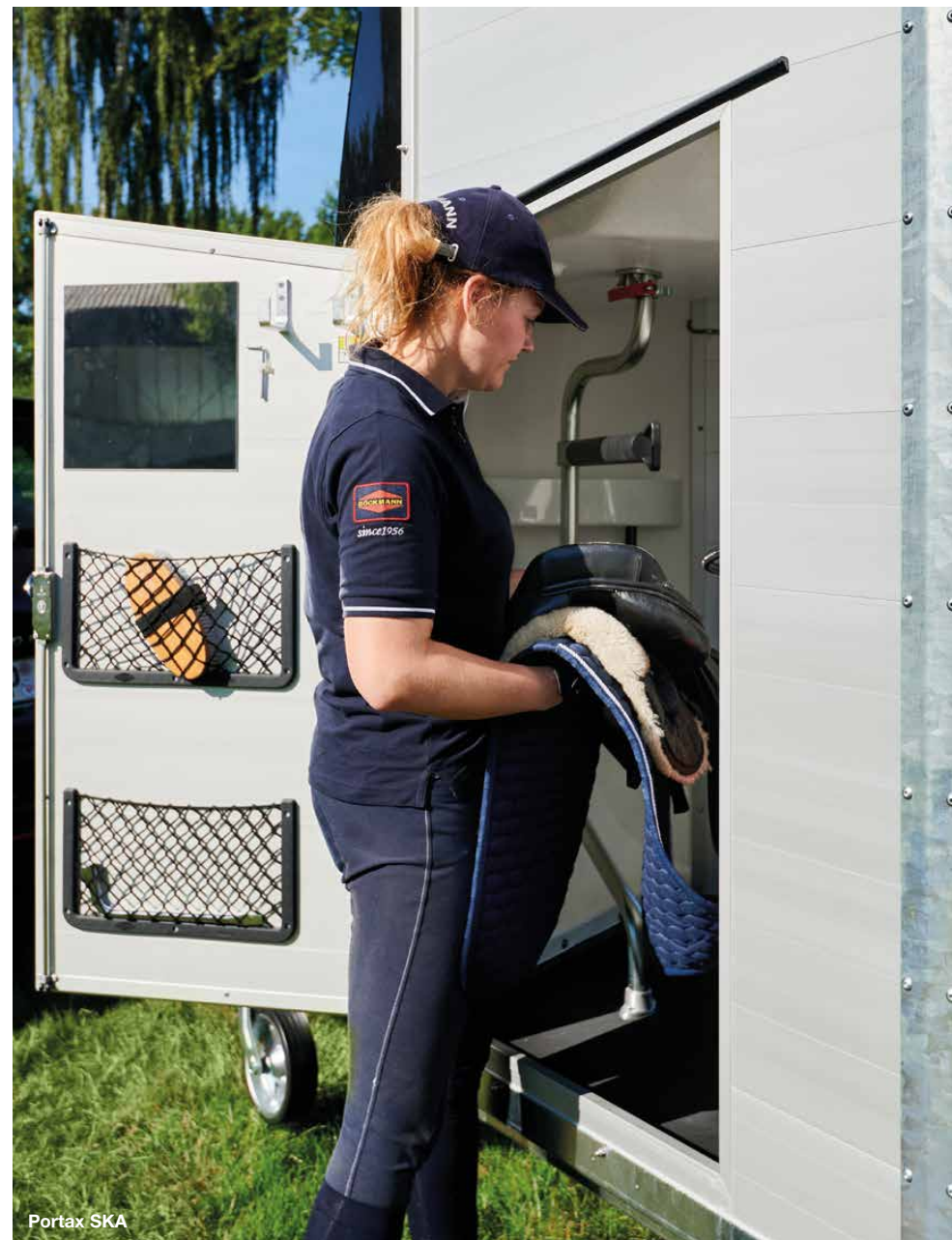

Portax SKA

The tack lockers. Portax E and Portax L E.

Two extra-large, interior tack locker doors make all the difference in the new Portax E models. The amount of space in this tack locker provides additional space in front of the horses and access to both sides of the horse compartment through two man-high entrance doors. The tack locker can be conveniently accessed from the horse compartment or indirectly from the outside through the two entrance doors.

We have summarised the extensive range of standard features and unique detailed solutions such as pull-out saddle racks, storage compartments, bridle hooks and folding stools for you on page 30.



Portax L E



Portax E

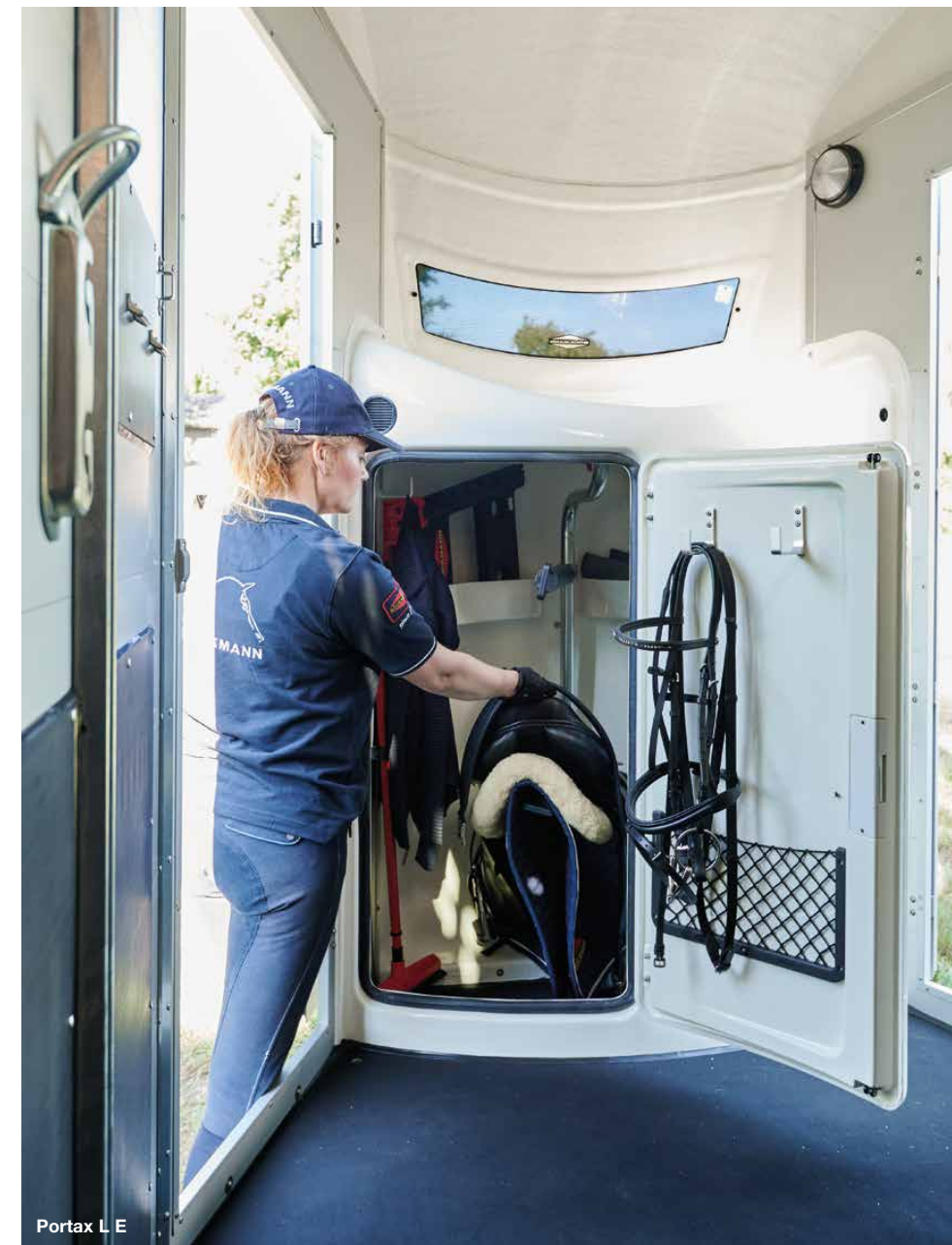

Portax L E

The tack lockers. Portax K and Portax L K.

The tack locker concept of the new Portax K models is perfectly designed to suit practical needs: The shape ensures plenty of freedom of movement during unloading through front exit without having to sacrifice storage space. On the contrary. The interior tack locker is conveniently accessible from the horse compartment through an extra-large door. In addition, the K models feature a man-high entrance door to the horse compartment through which the tack locker can also be indirectly and conveniently reached.

We have summarised the extensive range of standard features and unique detailed solutions such as pull-out saddle racks, storage compartments, bridle hooks and folding stools for you on page 30.



Portax K



Portax L K



Portax L K

The tack room. Portax L SR.

The new Portax L SR model offers a unique space concept – a walk-in storage space. The numerous detailed solutions leave nothing to be desired in terms of convenient use and storage space. Access is possible through the man-high exterior door. The horse compartment is also accessible on both sides through two man-high entrance doors. A connecting door can be selected from the range of accessories.

We have summarised the extensive range of standard features and unique detailed solutions such as pull-out saddle racks, storage compartments, bridle hooks and folding stools for you on page 30.



Portax L SR



Portax L SR



Portax L SR

The tack room. Big Portax.

The largest in its class: The man-high, walk-in tack room in the Big Portax horse trailer. This tack room has the same generous proportions as the Big Portax itself and offers an unparalleled amount of space with numerous detailed solutions, right down to the folding seat with boot jack. The man-high entrance door with integrated window makes it a real pleasure to use, and a second entrance door is available as an optional accessory.

We have summarised the extensive range of standard features and unique detailed solutions such as pull-out saddle racks, storage compartments, bridle hooks and folding stools for you on page 30.

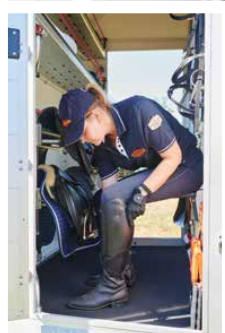

The tack room. Big Portax Stall.

In addition to the generous dimensions and features of the Big Portax, the Big Portax Stall offers unique practical added value with the man-high hinged doors in the partition wall. This allows comfortable access to the horse compartment and perfect handling. In addition, the tack room can be conveniently accessed through a particularly high exterior door.

We have summarised the extensive range of standard features and unique detailed solutions such as pull-out saddle racks, storage compartments, bridle hooks and folding stools for you on page 30.

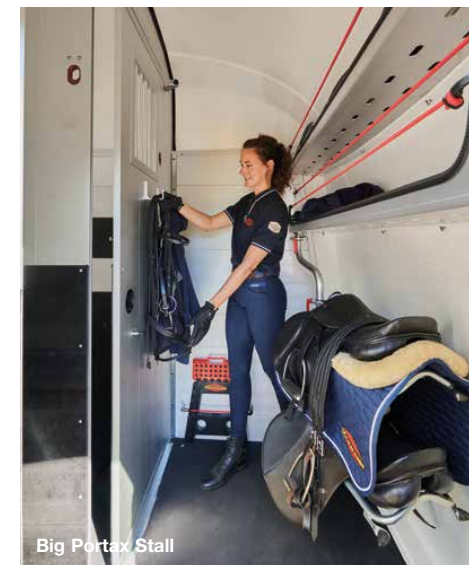

The Portax lighting bow. Bright delight.



The sliding windows on the sides let in plenty of indirect light, creating a bright interior.

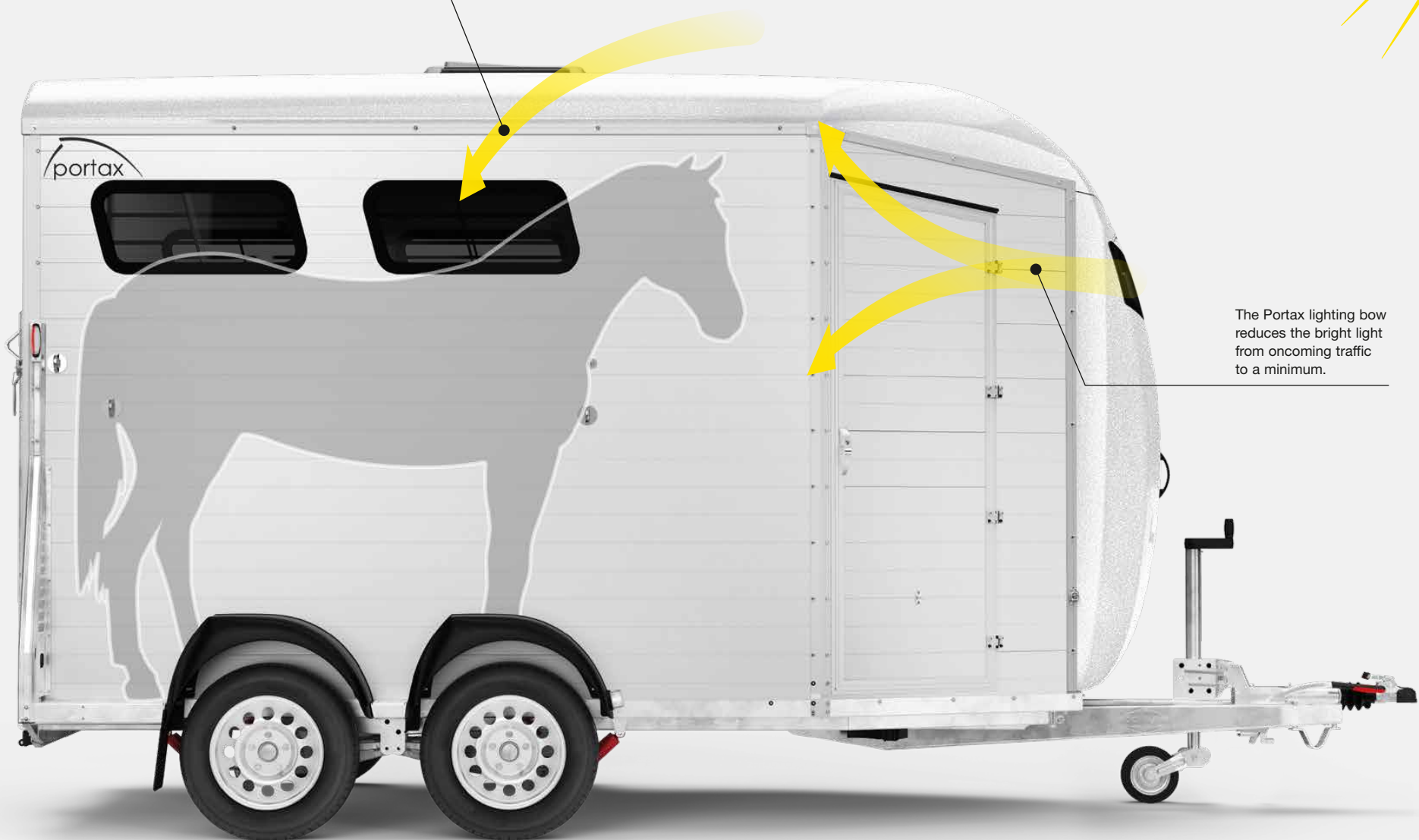

The Portax lighting bow reduces the bright light from oncoming traffic to a minimum.

Portax lighting bow



Especially soothing atmosphere with the new Portax lighting bow. This reduces direct glare to a minimum, significantly reducing disturbing factors for the horses.

Direct glare

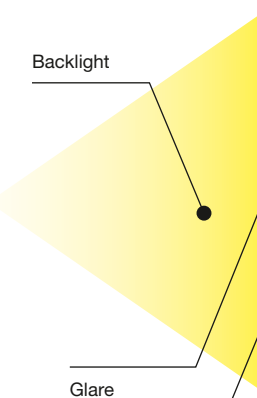

Backlight
Field of view
Glare

Conventional panoramic windows



Large panoramic windows offer a large exposure area for glare. The horse is often directly exposed to light sources such as high beams, flashing blue lights and sunlight.



Optimum transport conditions; bright, stress-free and protected

The lateral sliding windows and the special Portax lighting bow provide a large window area and therefore ensure optimum and stress-free transport conditions for your horses – a particularly bright and inviting interior, protection against dazzling oncoming traffic, no direct sunlight exposure, excellent ventilation and grilles for additional safety.

Good for your horse.

The loading height, the light interior with plenty of headroom, the Multi Safe System (MSS) and the absolute absence of sharp corners and edges – the safety of your horses is our main priority. These detailed solutions – standard features on all Böckmann horse trailers of the new Portax family – have been developed on the basis of 65 years of experience gained with our own horses and have been consistently adapted to their well-being and comfort.

For further details on the **Böckmann safety concept** and the added values visit www.boeckmann.com



Large and inviting entrance

due to the narrow roof edges, interior canvas lift and the bright, white interior walls. At night the interior lighting provides sufficient light in the interior.



Low loading height

with the lowered World-Class chassis (WCF) with galvanised independent wheel suspension, coil spring suspension and wheel shock absorbers.



Optimum foothold and minimised risk of slipping

due to safety treads, side stops on the rear ramp covering and the closed, narrow rear ramp hinge.

Lots of room for a wide stance

due to securing of the PVC curtain 600mm above the floor – for comfortable transport (Böckmann partition wall is an optional accessory).



Böckmann partition wall



Böckmann centre post partition wall

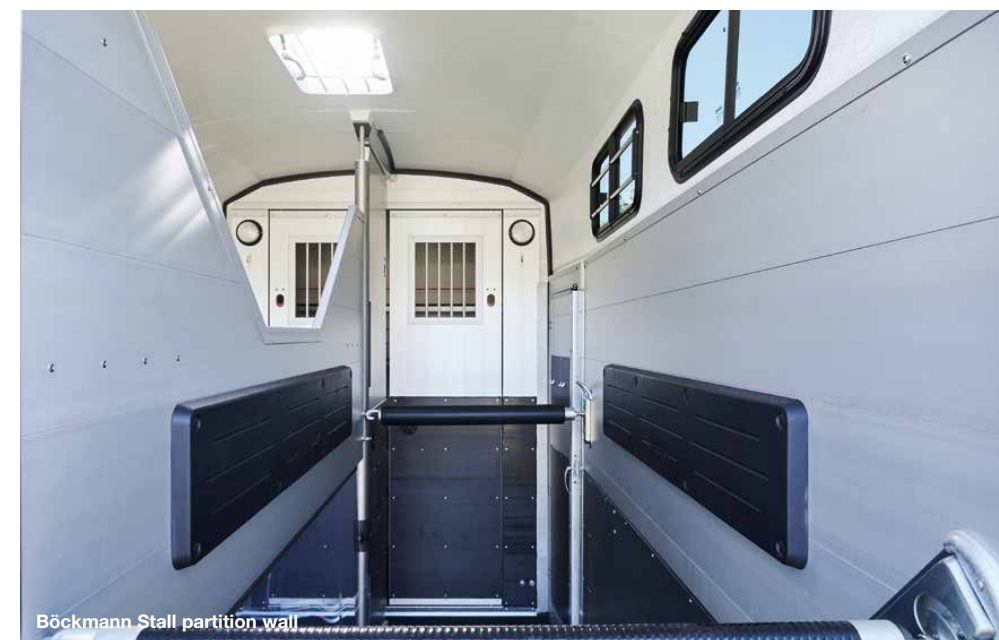

Böckmann Stall partition wall

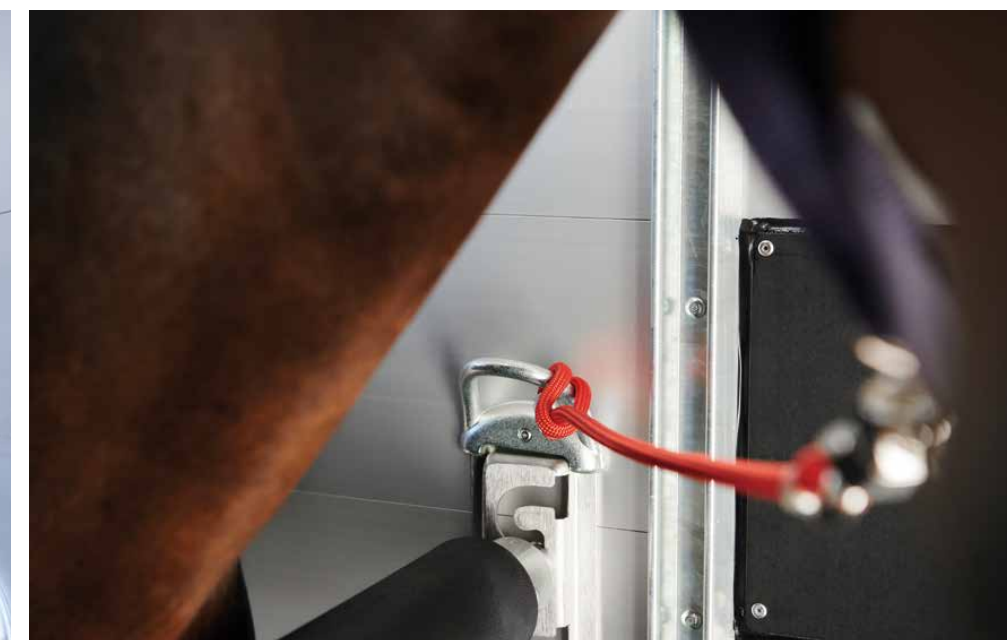

Safe transport

is ensured by the track-proven Böckmann partition wall system and the safety stall bar system (MSS) with tie rings and an adjustable height range of 10 cm. Further protection is provided by the additional stall bar padding as well as the tack locker in front of the horses (the latter is available as an accessory for the Portax SKA and L SKA). Also refer to page 54.



No slipping of the horse's hooves
due to closed, specially perforated rear struts.

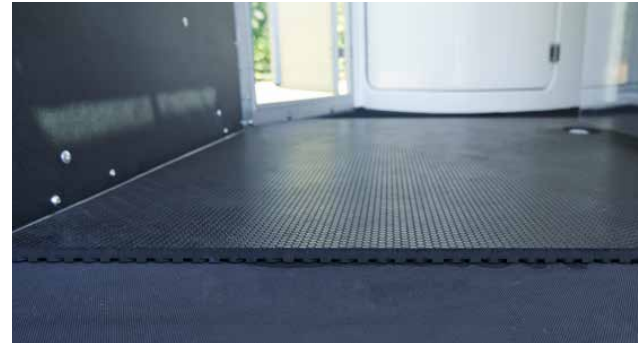

Safe to stand on
due to the rubber floor with non-slip textile structure. Wear mat standard feature on Portax L and Big Portax models.



No sharp edges and corners
ensured by rounded hinges and plastic covers on the steel profile struts and at the ends of the rear struts.



Safety
with the robust, angle lever locks with 180° rotation that minimise the risk of injury to your horse.



PVC canvas lift
with roll-up function [1] and integrated net (not with the Big Portax models) [2].



Good ventilation, brightness and sun protection
with several horizontally opening side windows with safety grilles and sunshades [1], as well as the new Portax lighting bow (not on Big Portax models) [2] at the front.



Plenty of headroom, space and light interior
ensured by the generous space concepts of the Portax family. The lateral sliding windows with integrated grille, large radii without corners and edges and flat hinges provide additional protection.



Calming atmosphere
provided by the blue LED transport light – can be conveniently switched from blue to white.

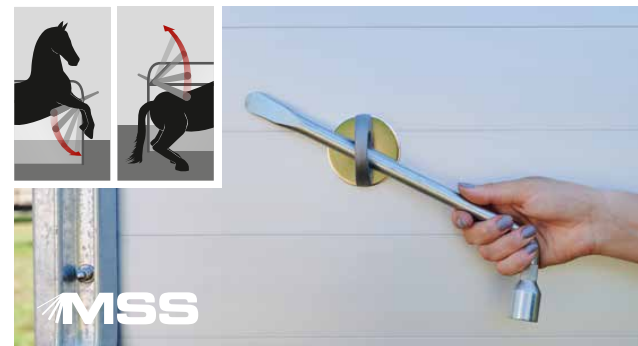

Fast safety in emergencies
with the track-proven Multi Safe safety stall bar panic system (MSS). Can be released at the front and rear. The wheel spanner is included in the standard equipment.



No entangling of the rope
due to flat door handles.



Plenty of room for the tail
due to the generous clearance between the stall bar and the rear ramp.



Easily accessible feed
with two safety feeding troughs with holder.



Easily accessible hay
with optimally positioned hooks for a hay net.

Good for you.

In addition to the needs of the horses, our horse trailers are tailored to the requirements of their riders. Innovations such as the chassis, the coupling and the automatic jockey wheel prove their worth in daily use.

Details such as the crop holder, the mounting step and the extra wide bridle hooks at the right place show that during development the main focus was on one main thing – practical experience for practical applications.

For further details on the extra advantages visit www.boeckmann.com



Optimum closure
with the 3-point door lock and rubber seal.



Safe hitching and unhitching
due to the lockable cast coupling with rubberised, convenient heart-shaped handle and soft top (crash protection).



Easy manoeuvring
due to the automatic jockey wheel – extra-long with an easy-to-handle crank and optimally positioned manoeuvring handle, perfect to use, even in cold weather.



Crash and theft protection
provided by the lockable cast-iron coupling with soft-top crash protection and rubberised, convenient heart-shaped handle.



Unimpeded access to the car boot
due to the rubberised, convenient heart-shaped coupling handle and the flat brake lever – also when attached.



Convenient operation
due to the easily accessible and separate light switch for the interior lighting on the right-hand entrance door.



Plenty of space for loading and unloading
due to the large entrance door and clearance between the stall bar and tack locker in the front area of the trailer.



Quick access to the horse compartment
through a large entrance door and plenty of space once inside.



One key for all locks
with a master key in triplicate for the tack locker door, entrance door and cast coupling.

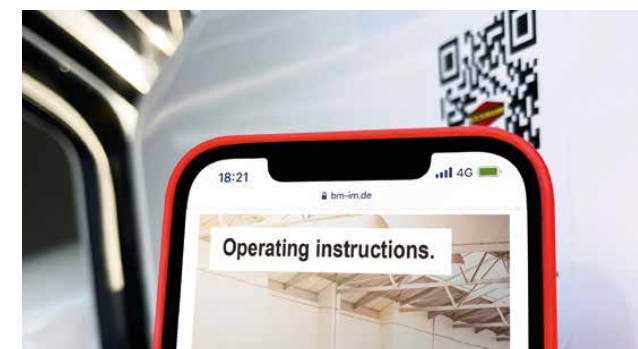

Fast access to the operating instructions
with the QR code directly on the vehicle.



Excellent view on the road
due to closed, specially perforated rear struts.



Protection from rain
provided by the rain gutters above the doors and also in the rear area.



More travelling safety
due to the large quality tyres (aluminium rims are accessories).



Practical protection against damage
with door catches on the doors.



Fenders as shelf
with the wide and open, straight form of the impact-resistant plastic or polyester fenders (accessory).



Travelling comfort
with the World-Class chassis to automotive standards with wheel shock absorbers.



Perfectly practical
due to the spacious proportions and many detailed solutions such as the tack lockers accessible from the inside and the swivelling centre post partition wall.



Tie options
with lots of fittings on and in the trailer.



Simple operation
due to the practical roll-up function of the canvas lift. Lifting device for easy opening of the rear ramp, additionally with robust double step.



Easy to tow
due to the aerodynamic body and low centre of gravity – also saves fuel.

Good for stable value.

Original Böckmann quality down to the last detail – for you this means durability and an excellent trade-in value achieved by absolutely solid workmanship and the use of high-quality materials. Experience the strength and safety of our horse trailers yourself.

For further details on the extra advantages visit www.boeckmann.com

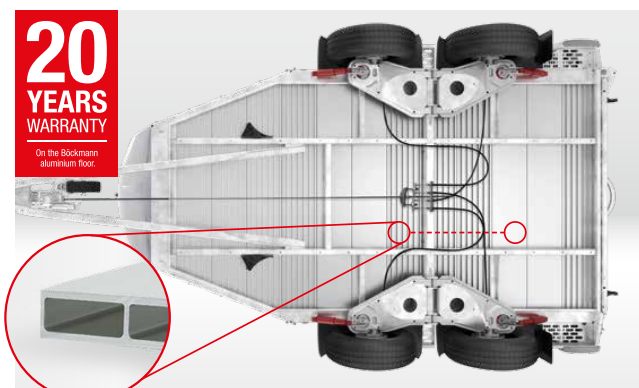

20 YEARS WARRANTY
On the Böckmann aluminium floor.

Robust, rot-proof and made for high loads
due to the solid quality full aluminium floor with closed profile for reinforcement in the horse compartment as well as the longitudinal beam construction and the welded, hot-dip galvanised steel frame.



Strong frame
with a full-length Z-profile frame of galvanised special steel – firmly bolted to the body.



Resilient
due to the fully bonded and sealed rubber floor (8 mm) throughout.

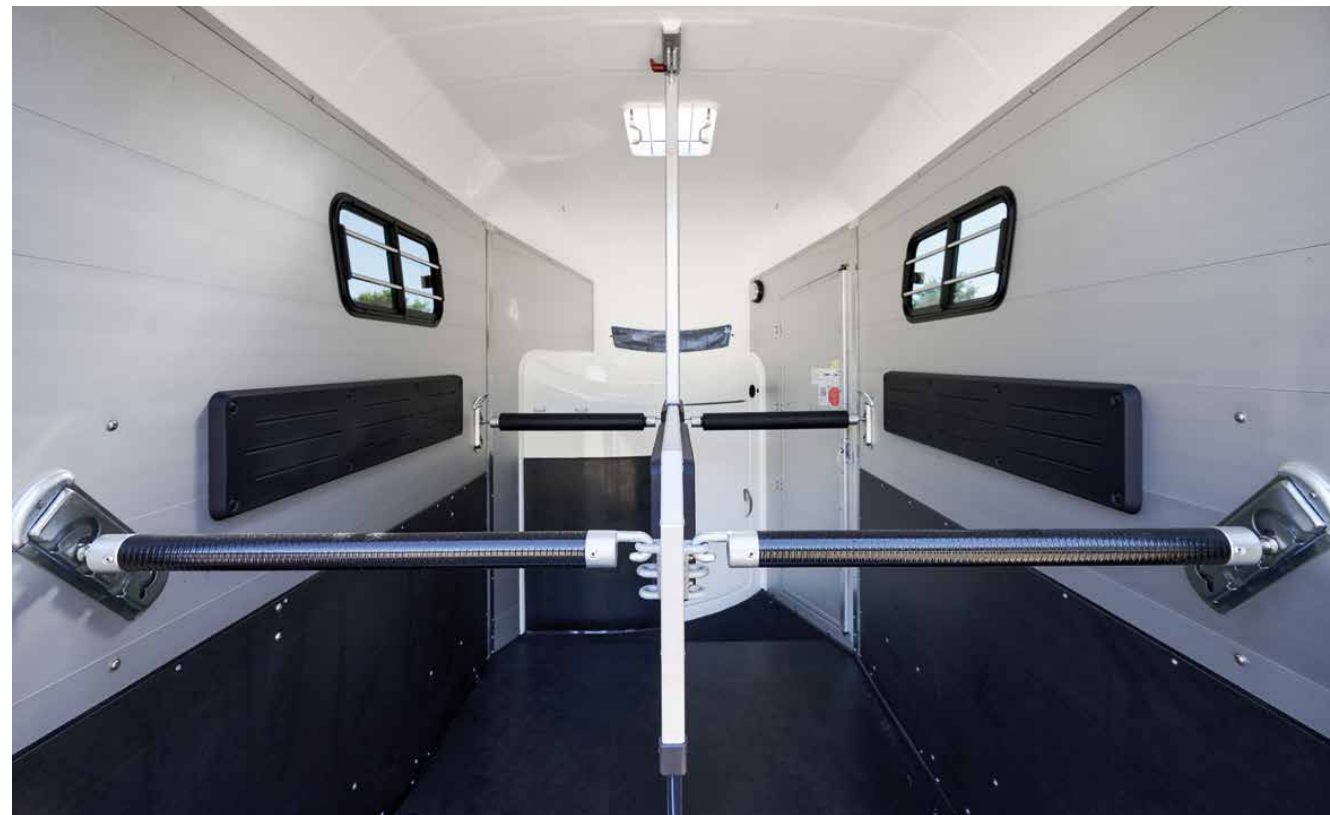

Kick protection
due to a particularly impact-resistant plastic on the side walls and in front of the horse (the latter is available as an accessory for the Portax SKA and Portax L SKA).



Strong partition wall construction and high-quality materials
with the solid, welded steel frame or the centre post partition wall made of anodised aluminium.



Robust rear ramp
with four galvanised steel profile struts with integrated lifting device; additionally with robust double step.



Anodised aluminium double web profile
for outstanding durability.



Sufficient payload
with 2700 kg as standard on the Portax L and Big Portax models. 2400 kg on the Portax SKA, Portax E and Portax K.

Great design.

Individuality in its most appealing form – all Portax models can be designed according to your taste. Many colour combinations are possible – from the roof and bow to the polyester fenders and covers for the side braces. We would also be pleased to offer you individual and photorealistic lettering according to your specifications.

Simply ask the Böckmann specialist dealer in your area.



The Portax LK with polyester roof and bow in yellow green³.



The Portax SKA with polyester roof and bow in dark blue metallic².



White²



Silver metallic¹



Anthracite metallic²



Slate grey³



Silver grey³



Dark blue metallic²



Red metallic²



Green metallic²



Dark brown metallic²



Royal blue³



Flame red³



Magenta³



Yellow³



Yellow green³



Deep orange³

¹ Standard ² Without surcharge ³ With surcharge

Experience has shown that printing inks cannot reproduce the original colour of paintwork. We therefore recommend that you ask your Böckmann partner to show you the colour samples. Individual colour combinations, special finishes as well as letterings based on your design are possible. Your Böckmann specialist dealer will be pleased to help you.

Great looks.

Create "your Böckmann" according to your personal preferences. Large or small decor, multi-colour or monochrome – the choice is yours. The decors are exclusively designed by Jan Künster for Böckmann. We would be pleased to create custom decors and custom sizes based on your design upon request. Your Böckmann partner would be pleased to help you.



Small decor
Positioning example of small decor motif "Competition, multi-colour".



Large decor
Positioning example of large decor motif "Competition, greyscale".



Strong trot, multi-colour

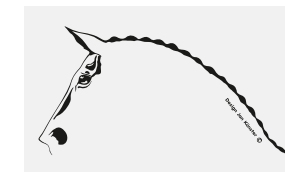

Horse's head

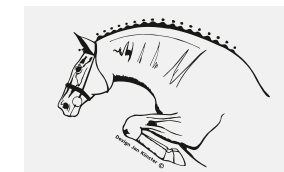

Jumper

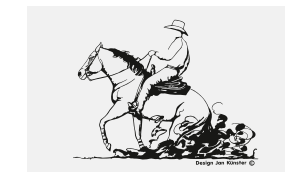

Western

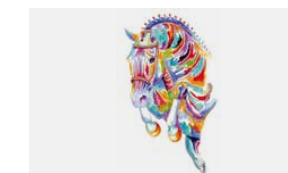

Jumper, multi-colour

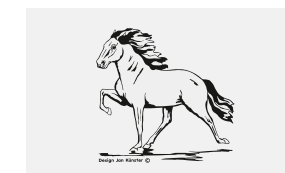

Gaited horse



Arabian



Driving sport

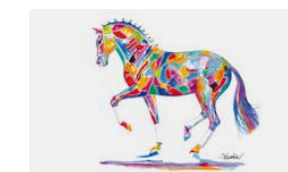

Piaffe, multi-colour

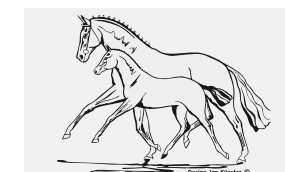

Mare with foal



Dressage



Frisian

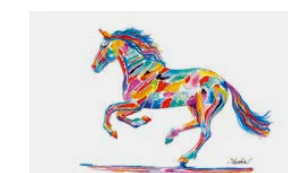

Gallop, multi-colour

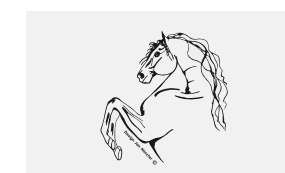

Andalusian

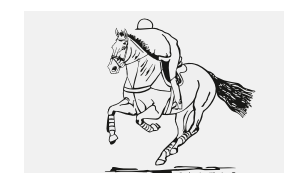

Military



Artline



Competition, multi-colour

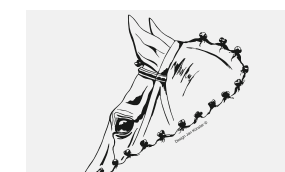

Competition

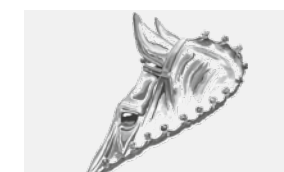

Competition, greyscale

All decors are available in anthracite as a standard feature. Additional decor colours available on request.

Accessories.

The range of standard features of the Portax family is extensive. The models have many details and innovations from which both horse and rider benefit. Even more is possible with the original Böckmann accessories – customise your Portax to suit your needs and those of your horses.



Safety on the road
with a folding foal grid.



Practical storage option
with a tie up bar for saddle and saddle pad (on the side of the trailer).



Professional saddle rack
with wide support surface for the Portax SKA and L SKA. Also ideally suited for western saddles (already standard on Portax K and LK, Portax L SR and Big Portax).



More light at the rear
with an additional interior light on the Portax SKA, Portax E and Portax K (two interior lights standard features on the Portax L and Big Portax models).



Everything in view
with the video surveillance of the horse compartment as well as an additional rear view camera.



Aluminium rear ramp
possible instead of a canvas lift for Portax and Portax L models.



Easy mounting
with the climbing aid that can be easily unfolded on the rear ramp; this also puts less strain on the horse's back.



Several safety features
such as the anti-torsion coupling [1] (up to 2.7 t total weight, not lockable), the weatherproof protective cover [2] and the spare wheel with spare wheel holder and a spare wheel cover [3].



Visual highlight
with the polyester covers for the side braces, the single polyester fenders, for example in the colour of the polyester roof, as well as the Böckmann Premium aluminium rims.

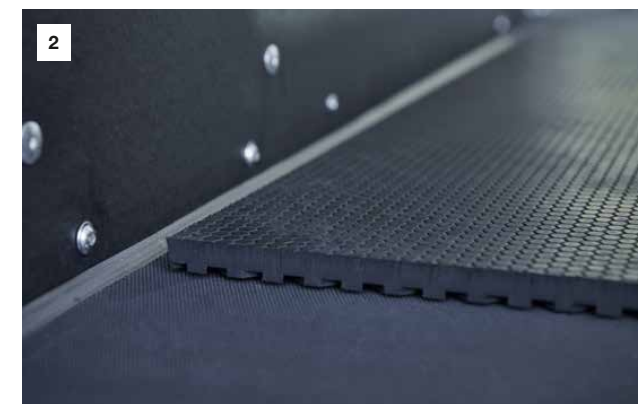

Durability
with the kick protection in front of the horses [1] (for the Portax SKA and Portax L SKA) and the wear mat in the area of the front legs [2] (Standard for Portax L and Big Portax models).



Safe transport

due to the aluminium head partition wall e.g. for transporting two stallions.



Sufficient payload

possible with a higher payload of 2700 kg total weight for the Portax SKA, Portax E and Portax K (already standard on the Portax L and Big Portax models).

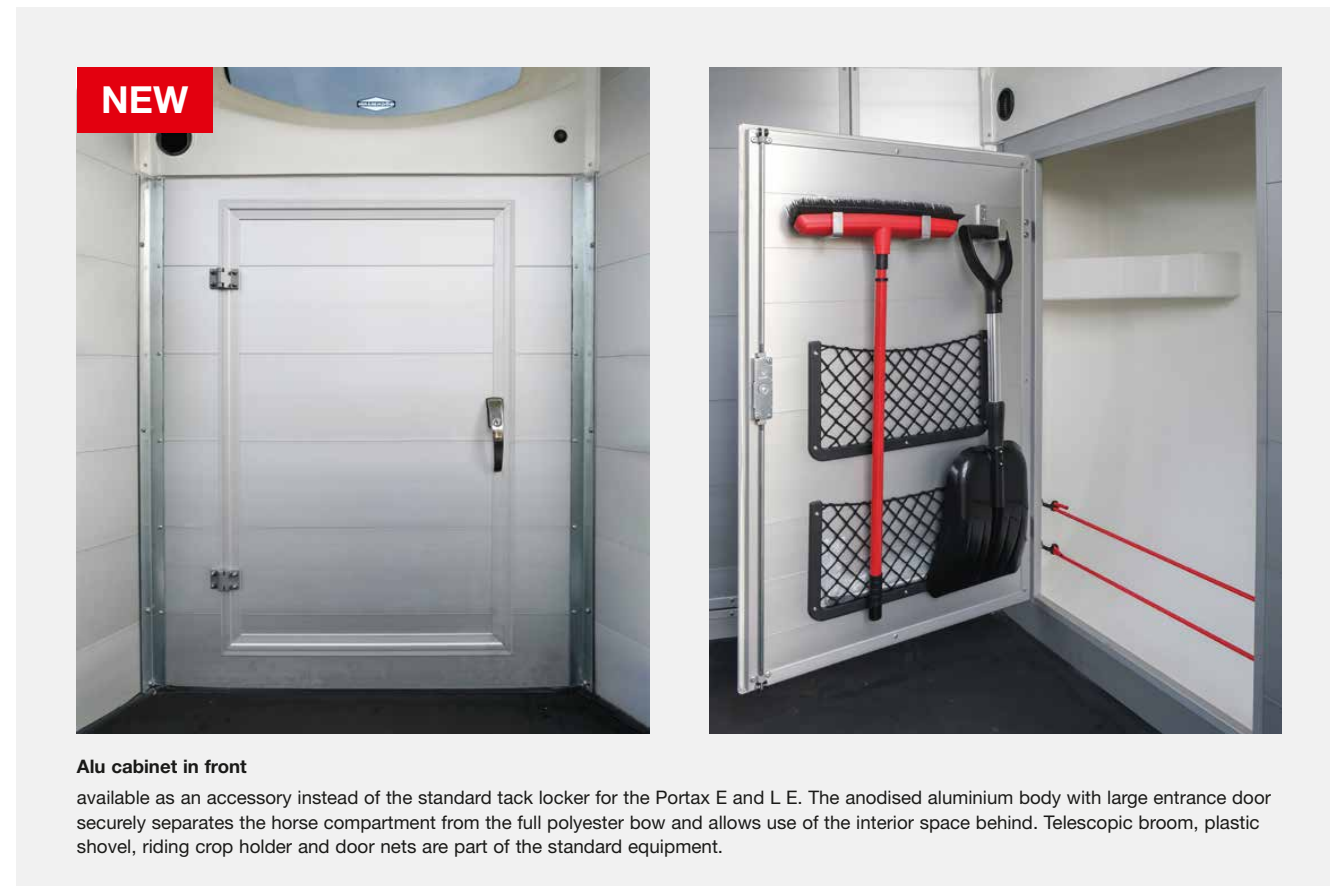

Alu cabinet in front

available as an accessory instead of the standard tack locker for the Portax E and L E. The anodised aluminium body with large entrance door securely separates the horse compartment from the full polyester bow and allows use of the interior space behind. Telescopic broom, plastic shovel, riding crop holder and door nets are part of the standard equipment.

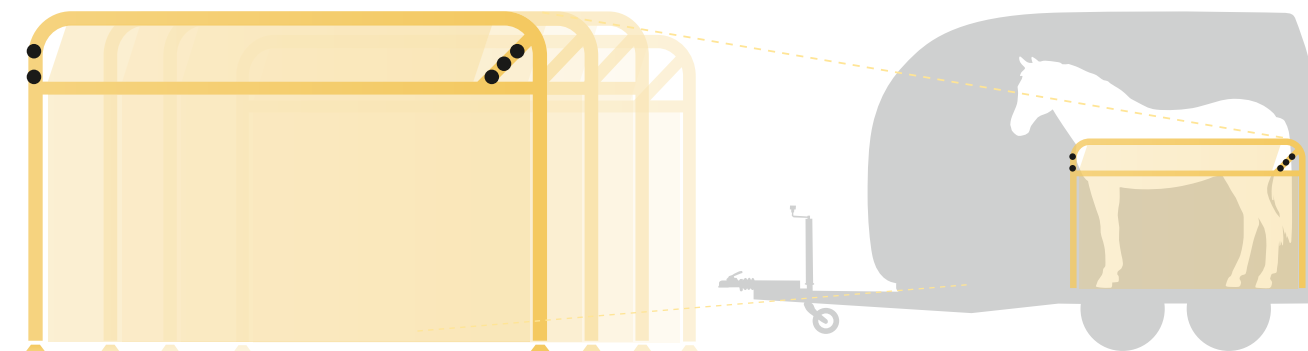

Comfortable transport for horses of all sizes

with the various partition wall concepts. All Portax models have the Böckmann centre post partition wall as a standard feature, the Big Portax Stall features the Böckmann Stall partition wall. As an option you can also equip your horse trailer with the Böckmann partition wall 165 for large horses (1.65 m height) at no extra charge in the accessory range (not possible with the Big Portax Stall) or request alternative partition wall heights.



Discover the full range of accessories
and configure your Portax online:

Scan the code now!



First class service.

As a Böckmann customer you will receive personal support with many service offers directly on site. Our dense network of competent and trained Böckmann sales partners is at your disposal worldwide. They will be able to provide you with the excellent trailer advice and top-notch service you need. We have put together more information and tips for you in our online service portal:



Original part orders

Guaranteed exact fit, reliability, durability in daily use and a higher resale value. Original Böckmann parts can be purchased from your local dealer.

www.boeckmann.com/en/accessories



Repair service

Trained employees take care of all repairs and the installation of original parts if necessary. Also together with the next general inspection upon request.

www.boeckmann.com/en/services



Böckmann magazine

Read our Böckmann magazine for important information, trade fair dates and helpful trailer tips. Take a look inside:

www.boeckmann.com/en/magazine/magazin



Böckmann FAQs

Frequently asked questions about transport, trucks and trailers. We support you with answers so that you are perfectly prepared for your transport task.

www.boeckmann.com/en/services/faqs

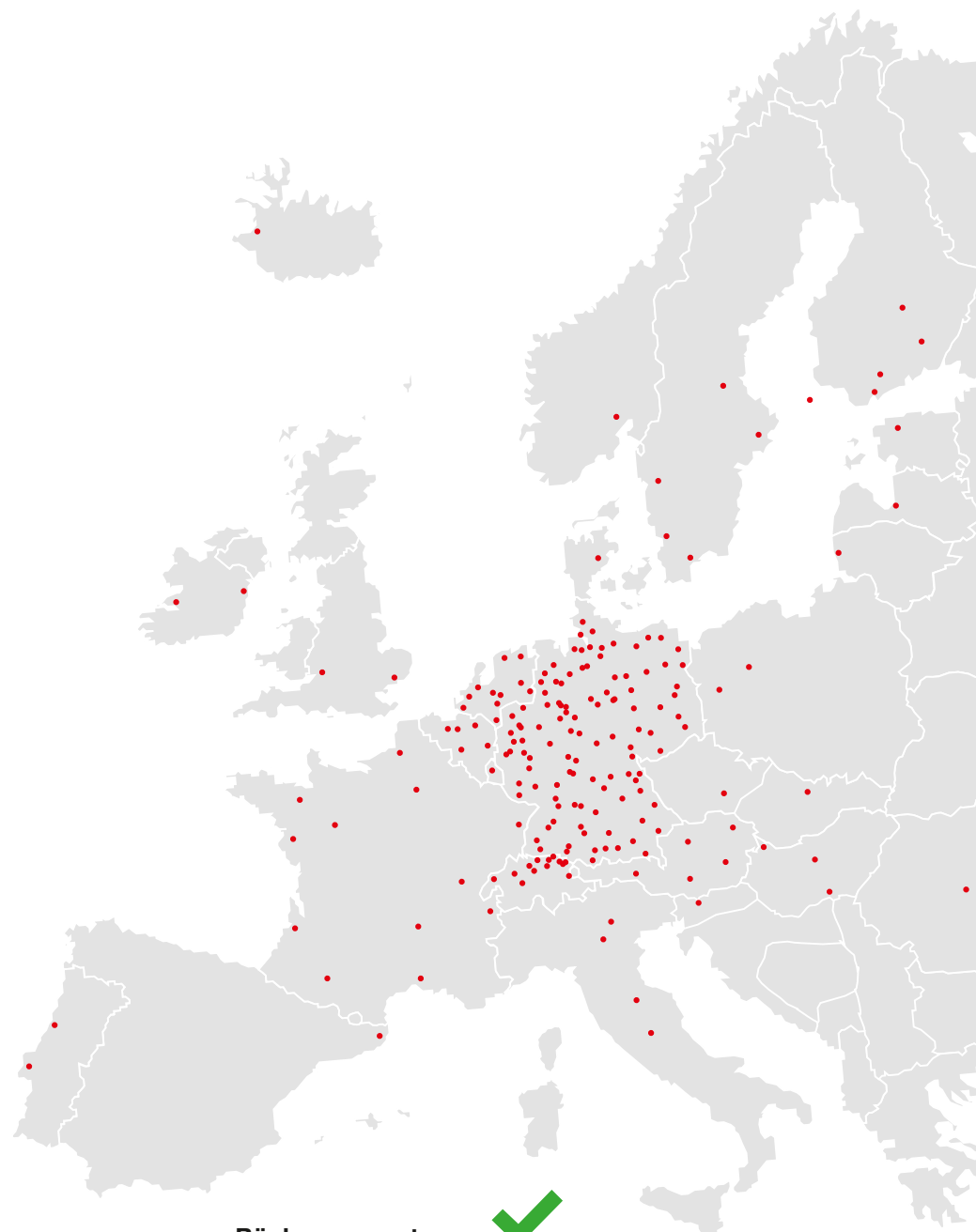

Böckmann partners

Find your personal Böckmann dealer at home and abroad with ease. Refer to our dealer locator at:

www.boeckmann.com/en/dealer-locator

Böckmann financing options.

Would you like to finance or lease a new Portax? Simply contact your local dealer and ask about the various options. Your Böckmann dealer will be happy to help you.

Ask your local dealer!



Trailers shown include special accessories in some cases.

Get moving with Böckmann. First class and hand in hand.

The Böckmann brand has stood for progress, quality and reliability since 1956. Our services and products are designed to inspire people time and time again and deliver real added value. "You have to put your heart and soul into the business to be successful in the long term" was the guiding principle of our founders. And this is still a living part of the company today and every day. Welcome to the world of Böckmann.



Böckmann trailers

A success story which started in 1956: As the trailers are used for Böckmann's own horses, they have been subjected to constant improvement over the years. In this way we became the international market leader for horse trailers.



Böckmann horses

Everything for your horses. Everything from one source. Everything in Hamstrup! Ranging from horse-friendly accommodation with individual care to foaling and successful training in dressage and show jumping by the renowned trainer Gilbert Böckmann and his team.



Böckmann transporters

Thanks to the experience of over 65 years of equestrian sport, we develop horse trucks that leave nothing to be desired. Whether in the living or sleeping compartment or the horse compartment – every single detail is designed and produced individually in Lastrup. And naturally hand-crafted. Let us advise you directly at the Truck Center.



Böckmann Collection

From sweat rugs to polo shirts to folding rules – discover the entire Böckmann Collection. Simply scan the QR code and explore the entire range.



Find out more about Böckmann:

f [facebook.com/anhangensterklasse](https://www.facebook.com/anhangensterklasse)

▶ [boeckmann.com/youtube](https://www.boeckmann.com/youtube)

@ [instagram.com/boeckmann.horses](https://www.instagram.com/boeckmann.horses)

Technical data

									
 Portax SKA	2400 kg	2815 mm	2350 mm	4725 mm	2350 mm	1750 mm	3560 mm	1300 kg	
 Portax L SKA	2700 kg	2815 mm	2350 mm	5355 mm	2350 mm	1750 mm	4190 mm	1480 kg	
 Portax E	2400 kg	2815 mm	2350 mm	4725 mm	2350 mm	1750 mm	3560 mm	1300 kg	
 Portax L E	2700 kg	2815 mm	2350 mm	5355 mm	2350 mm	1750 mm	4190 mm	1470 kg	
 Portax K	2400 kg	2815 mm	2350 mm	4725 mm	2350 mm	1750 mm	3560 mm	1265 kg	
 Portax L K	2700 kg	2815 mm	2350 mm	5355 mm	2350 mm	1750 mm	4190 mm	1415 kg	
 Portax L SR	2700 kg	2815 mm	2350 mm	5355 mm	2350 mm	1750 mm	4190 mm	1415 kg	
 Big Portax	2700 kg	2935 mm	2410 mm	5535 mm	2400 mm	1855 mm	4150 mm	1370 kg	
 Big Portax Stall	2700 kg	2935 mm	2410 mm	5535 mm	2400 mm	1855 mm	4150 mm	1310 kg	

Changes to design and equipment reserved. Weights and dimensions approximate and may change due to additional equipment. Some illustrations in this brochure do not show standard equipment.

Your Böckmann specialist dealer for consulting and service:

Böckmann Fahrzeugwerke GmbH 49688 Lastrup

Phone +49 (0) 4472 895-0

info@boeckmann.com www.boeckmann.com

f facebook.com/anhangensterklasse ▶ boeckmann.com/youtube

@ instagram.com/boeckmann.horses



FIRST CLASS TRANSPORT